



Tower Dryer

Models:

12', 18', 24' and 30' Diameter

Operation and Service Manual - 2023

PNEG-526

Version: 8.0

Date: 05-26-23



PNEG-526

A graphic with a background of a tower dryer's internal structure. It contains the following text:

Tower Dryer Maintenance & Service
www.gsiag.com/service
Tech Support: 1-217-226-5756
US Fax: 1-866-656-3297
Int'l Fax: 1-217-226-3404
Email: gsi-gsifixt@agcocorp.com

The GSI logo is also present on the left side of the graphic.

**THIS PRODUCT IS PROTECTED UNDER ONE OR MORE
OF THE FOLLOWING U.S. PATENTS:**

**6233843, 6189235, 6141886, 6101742, 6098305, 6088929, 6076276,
6073367, 6073364, 5570521, 6457256, 6035544, 5860221, 5653043,
5651193, 5604996, 5566470, 5400525**

All information, illustrations, photos, and specifications in this manual are based on the latest information available at the time of publication. The right is reserved to make changes at any time without notice.

Contents

Chapter 1 Safety	4
Safety Guidelines	4
Cautionary Symbols Definitions	5
Safety Cautions	6
Safety Sign-Off Sheet	11
Chapter 2 Decals	12
Chapter 3 Tower Dryer Operations and Service	13
Installation Requirements	13
Dryer Control Panel	14
Dryer Start-Up	16
Chapter 4 Optional Tri-Point Moisture Controller	22
Main Screen	22
Set-Up of the Controller	23
Operation Procedure	24
How the Controller Works	25
Alarms	26
Access Drying History	27
Chapter 5 Maintenance	28
Pre-Seasonal Inspection and Service	28
Seasonal Inspection and Service	29
Pre-Season Service Check List	32
End of Season Shut Down Procedure	32
Chapter 6 Troubleshooting	33
Drying Issues	33
Burner	34
General	35
OIU (Screen) Messages	36
Chapter 7 Parts List	39
Commercial Tower Dryer Common Service Parts	39
Commercial Tower Dryer Sidewall Sheets - GSI and ZIMMERMAN Inside Galvanized Sheets	45
Commercial Tower Dryer Corrugated Sidewall Sheets - GSI Only - Outside Stainless Sheets	46
Commercial Tower Dryer Sidewall Sheets - ZIMMERMAN Only - Outside Stainless Sheets	47
Chapter 8 Tower Dryer - Domestic Wiring Diagrams	50
Chapter 9 Tower Dryer - CSA Wiring Diagrams	106
Chapter 10 Warranty	135

1. Safety

Safety Guidelines

Safety guidelines are general-to-specific safety rules that must be followed at all times. This manual is written to help you understand safe operating procedures and problems that can be encountered by the operator and other personnel when using this equipment. Read and save these instructions.

As owner or operator, you are responsible for understanding the requirements, hazards, and precautions that exist and to inform others as required. Unqualified persons must stay out of the work area at all times.

Alterations must not be made to the equipment. Alterations can produce dangerous situations resulting in **SERIOUS INJURY** or **DEATH**.

This equipment must be installed in accordance with the current installation codes and applicable regulations, which must be carefully followed in all cases. Authorities having jurisdiction must be consulted before installations are made.

When necessary, you must consider the installation location relative to electrical, fuel and water utilities.

Personnel operating or working around equipment must read this manual. This manual must be delivered with equipment to its owner. Failure to read this manual and its safety instructions is a misuse of the equipment.

ST-0001-4

Cautionary Symbols Definitions

Cautionary symbols appear in this manual and on product decals. The symbols alert the user of potential safety hazards, prohibited activities and mandatory actions. To help you recognize this information, we use the symbols that are defined below.



This symbol indicates an imminently hazardous situation which, if not avoided, **will result in serious injury or death.**



This symbol indicates a potentially hazardous situation which, if not avoided, **can result in serious injury or death.**



This symbol indicates a potentially hazardous situation which, if not avoided, **can result in minor or moderate injury.**



This symbol is used to address practices not related to personal injury.



This symbol indicates a general hazard.



This symbol indicates a prohibited activity.



This symbol indicates a mandatory action.

ST-0005-2

1. Safety

Safety Cautions

Use Personal Protective Equipment

- Use appropriate personal protective equipment:

Eye Protection



Respiratory Protection



Foot Protection



Hearing Protection



Head Protection



Fall Protection



Hand Protection



- Wear clothing appropriate to the job.
- Remove all jewelry.
- Tie long hair up and back.

ST-0004-1

Follow Safety Instructions

- Warning: If the information in the manual is not followed exactly, a fire or explosion can result, causing property damage, personal injury or loss of life.
- Carefully read all safety messages in this manual and safety signs on your machine. Keep signs in good condition. Replace missing or damaged safety signs. Be sure new equipment components and repair parts include the current safety signs. Replacement safety signs are available from the manufacturer.
- Learn how to operate the machine and how to use controls properly. Do not let anyone operate without instruction.
- If you do not understand any part of this manual or need assistance, contact your dealer.
- Retain these instructions for future reference.



ST-0025-3

Install and Operate Gas-Fired Equipment Properly

- Gas-fired equipment should be installed by a qualified pipe fitter and must conform with local codes.
- For Canada: The equipment shall be installed in accordance with the *Natural Gas and Propane Installation Code, CSA B149.1*, or the *Propane Storage and Handling Code, CSA B149.2*, or applicable provincial regulations, which should be carefully followed in all cases. Authorities having jurisdiction should be consulted before installations are made.
- For the United States: The equipment shall be installed in accordance with the *National Fuel Gas Code ANSI Z223.1/NFPA 54*.



ST-0016-2

For Your Safety

- If you smell gas:
 - Do not try to light any appliance.
 - Extinguish any open flames.
 - Do not touch any electrical switch.
 - Immediately call your gas supplier. Follow the gas supplier's instructions.
 - If you cannot reach your gas supplier, call the fire department.
- The use and storage of gasoline and other flammable vapors and liquids in open containers in the vicinity of this appliance is hazardous.
- Improper installation, adjustment, alteration, service or maintenance can cause property damage, injury or death. Read the installation, operating and maintenance instructions thoroughly before installing or servicing this equipment. Installation and service must be performed by a qualified installer, service agency or the gas supplier.



ST-0024-1

Install and Operate Electrical Equipment Properly

- Electrical controls must be installed by a qualified electrician and must meet the standards set by applicable local codes (National Electrical Code for the US, Canadian Electric Code, or EN60204 along with applicable European Directives for Europe).
- Lock-out power source before making adjustments, cleaning, or maintaining equipment.
- Make sure all equipment and bins are properly grounded.



ST-0075-1

1. Safety

Maintain Equipment and Work Area

- Understand service procedures before doing work.
- Keep area clean and dry.
- Do not service equipment while it is operating. Disconnect and lock-out power and fuel supply before entering equipment or before performing maintenance.
- Keep your equipment in proper working condition. Replace worn or broken parts immediately.
- Depressurize the fuel train before disassembling for service.
- Allow the fan to operate for 20 minutes with the burner off to purge products of combustion and to cool the components before entering.
- Check regularly for any developing gas plumbing leaks. Do not operate the dryer if any gas leak is detected. Shut down and repair before further operation.



ST-0030-2

Exercise Caution When Drying Flammable Grains

- Be aware that some grains are highly flammable including, but not limited to, rapeseed, canola, linseed, sunflower and milo.
- All grain and seed must be whole (minimal cracking or crushing), clean, and dust free before drying.
- Avoid dust and chaff from being drawn into the fan and heater.
- To reduce risk of fire, keep the fan, heater, drying plenum, and ducts clean at all times.
- In the event of a fire (or suspected fire):
 1. Shut down the entire dryer.
 2. Turn off the fuel at the tank or supply valve.
 3. Shut off and lock electrical power.
 4. Evacuate the area.
 5. Call the fire department.



ST-0032-1

Fall Hazard

- Keep access door closed while on a platform to avoid falls.
- Always use proper personal protective equipment and proper clothing when using equipment. Failure to follow safety precautions can result in severe injury or death.



ST-0042-2

Maintain Equipment and Work Area

- Equipment is intended for the use of grain drying only. Any other use is a misuse of this equipment.
- The operating instructions in this manual pertain to the common cereal grains as indicated. When drying any other grain, contact GSI for additional recommendations.
- Be certain that capacities of auxiliary conveyors are matched to dryer metering capacities.
- On LP fired units, set pressure regulator to avoid excessive gas pressure applied to the burner during ignition and operation. Do not exceed maximum recommended drying temperatures.
- Equipment has sharp edges that can cause serious injury. To avoid injury, handle sharp edges with caution and use proper protective clothing and equipment at all times.
- All guards must be in place before and during operation. Images of guards removed in this manual are for illustration purposes only.
- Use caution when working around high-speed fans, gas burners, augers and auxiliary conveyors which can start automatically.
- Keep hands, feet, and clothing away from moving parts.
- Do not bypass any safety device or interlock.
- Do not enter the dryer or bin while it is operating.
- Do not operate in an area where combustible material will be drawn into the dryer.

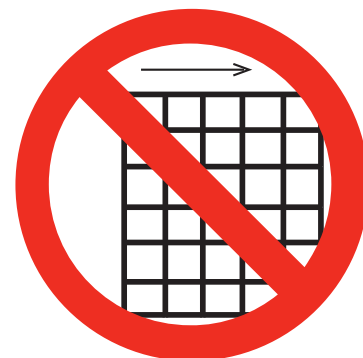

ST-0034-2

Stay Clear of Hoisted Equipment

- Always use proper lifting or hoisting equipment when assembling or disassembling equipment.
- Do not walk or stand under hoisted equipment.
- Always use sturdy and stable supports when needed for installation. Not following these safety precautions creates the risk of falling equipment, which can crush personnel and cause serious injury or death.



ST-0047-1

1. Safety

Confined Space Hazards and Entry Procedures

- Note that the interior of this equipment is considered a confined space. Maintenance of this equipment can require access to the confined space.
- Access doors must be shut and locked except when access is required.
- Doors giving access to dangerous equipment must be safety interlocked.
- The following entry procedures must be followed:
 - Be aware of all possible hazards present inside the confined space and wear personal protective equipment (PPE) as needed.
 - Complete a permit to work and follow all permit required confined space entry procedures defined by the site manager.
 - Make sure that the area has been purged of any hazardous products or gases. Check the atmosphere for harmful gases or vapors with a suitable gas analyzer and make sure levels are safe before entering.
 - Do not smoke or use naked flames.
 - Lock out and tag out power supplies and fuel supplies to all equipment.
 - Do not work alone. Work in teams of at least three so that help is immediately available in the event of an emergency.
 - Confirm that all personnel have safely exited the equipment and tools have been recovered once work is complete.



ST-0055-1

Fall Hazard

- Ladders, stairways and platforms are for use by competent and trained personnel only. Do not allow children or other unauthorized persons to have access to the equipment.
- Access to the equipment must be restricted by the use of security fencing and lockable gates.
- Lower sections of ladders must be fitted with a lockable safety gate to prevent unauthorized access.
- Make sure that hot surfaces have had adequate time to cool before working on or in the equipment.
- Lock out and tag out power supplies and fuel supplies to all equipment.
- Do not attach lifting equipment to ladders or platforms.
- Do not go outside of the safety rails provided on elevated platforms.
- Do not work at heights during high winds, rain, snow, or ice storms.



ST-0056-1

Install and Operate Equipment Properly

- Before attempting to remove and reinstall the fan blade, contact GSI for the recommended procedure.



ST-0033-2

Safety Sign-Off Sheet

Below is a sign-off sheet that can be used to verify that all personnel have read and understood the safety instructions. This sign-off sheet is provided for your convenience and personal record keeping.

<i>Date</i>	<i>Employee Name</i>	<i>Supervisor Name</i>

ST-0007

2. Decals

The GSI Group principle concern is your safety and the safety of others associated with grain handling equipment. This manual was written with that thought in mind. We want to keep you as a customer by helping you understand safe operating procedures and some of the problems that may be encountered by the dryer operator or other personnel. As owner and/or operator, it is your responsibility to know what requirements, hazards and precautions exist and to inform all personnel associated with the equipment or who are in the dryer area. Avoid any alterations to the equipment. Such alterations may produce a very dangerous situation, where serious injury or death may occur.

The GSI Group, Inc. recommends you contact your local power company and have a representative survey your dryer installation, so your wiring will be compatible with their system and you will have adequate power supplied to your unit.

Safety decals should be read and understood by all people in and around the dryer area. If the following safety decals are not displayed on your dryer or if they are damaged, contact The GSI Group for replacement:

GSI Decals

1004 E. Illinois St.
Assumption, IL. 62510
Phone: 1-217-226-4421

 <p>! DANGER</p> <p>The GSI Group 217-226-4421</p> <p>AMPUTATION HAZARD. Rotating drum below. Will cause serious injury or death. LOCKOUT power before entering or servicing.</p> <p>DC-1060</p>	 <p>! WARNING</p> <p>GSI Group Inc. 217-226-4421</p> <p>Flame and pressure beyond door. May cause serious injury. Do not enter when dryer is running.</p> <p>DC-1061</p>	 <p>! DANGER</p> <p>GSI Group 217-226-4421</p> <p>DO NOT STAND ON DRUM!</p> <ul style="list-style-type: none"> • Rotating drum will cause serious injury or death. • Disconnect power before servicing. <p>DC-1062</p>
 <p>! CAUTION</p> <p>The GSI Group 217-226-4421</p> <p>AIRBORNE PARTICLES DURING OPERATION. May impair vision and breathing. Do not enter when dryer is running.</p> <p>DC-1063</p>	 <p>! WARNING</p> <p>GSI Group 217-226-4421</p> <p>High speed belt drive operating overhead. Can cause serious injury. Keep head and hands clear. Do not enter when dryer is running.</p> <p>DC-1064</p>	 <p>! DANGER</p> <p>GSI Group 217-226-4421</p> <p>High voltage. Will cause serious injury or death. Lockout power before servicing.</p> <p>DC-1224</p>
 <p>! WARNING</p> <p>GSI Group 217-226-4421</p> <p>Stay clear of rotating blade. Blade could start automatically. Can cause serious injury. Disconnect power before servicing.</p> <p>DC-1225</p>		

Installation Requirements

Electrical

The dryer can be furnished to operate off of 240, 480 or 575 volt, 60 Hz power or 380 volt, 50 cycle power. The dryer is furnished with a power panel equipped with a main circuit breaker disconnect and motor starters and branch breakers for the individual blower motors. Standard blower motor starting is across-the-line starting. When necessary, the dryer can be equipped with optional soft-start motor starting equipment.

No dry grain conveyor is furnished with the dryer, however, a 10 HP motor starter for a dry grain conveyor is furnished in the control panel. If the dryer is ordered with a demand fill, a 10 HP motor starter is also provided in the control panel to operate a wet conveyor.

GSI personnel will perform all necessary dryer wiring from the power panel to the dryer. The customer is responsible for bringing electrical power into the main circuit breaker and also for wiring the unload (and load) conveyor.

A wiring diagram is furnished with each dryer. Extensive safety controls are used on the dryer for equipment and personnel protection and should not be bypassed.

Fuel

The burner is designed to burn either natural gas or propane vapor fuel. The volume of fuel supplied must be sufficient to maintain a minimum of 7 PSI to 10 PSI pressure when the burner is operating at rated capacity.

When propane is used as the fuel source, external propane vaporizers must be used in order to supply vapor gas to the dryer. Vaporizers must be sized to the burner capacity of the dryer. Fuel pressure to the dryer must be regulated to approximately 10 PSI.

GSI personnel will plumb all necessary gas piping from the dryer's gas shut off valve to the burner. The customer must provide fuel to the gas shut off valve.



Figure 3A

Dryer Control Panel



Figure 3B The grain dryer control panel with full color touch screen control.

Dryer Control Panel Featuring the Allen Bradley PLC Control System

1. **Full Color Graphical Display** provides continuous visual feedback on the current dryer status as well as a convenient means of setting operating parameters and options. Most set points and status screens are accessed by simply touching an on-screen object.
2. **Message Center** displays current dryer conditions and alarm messages with troubleshooting tips in easy to read language.
3. **Dryer View** provides a quick visual indication of primary dryer functions as well as easy access to current burner and grain flow status screens.
4. **Temperature/Moisture History Chart** records up to 32 hours of dryer temperature and/or moisture data (with optional moisture control). The chart can be easily “rewound” to view earlier drying conditions.
5. **Control Power Switch** energizes the control panel and the PLC Control System. (**NOTE: It takes approximately 60 seconds to power up the Full Color Graphical Display once the Control Power Switch is turned ON**).
6. **Outside light switch** turns the dryer service light ON or OFF. On “AUTO”, the light turns ON when the dryer is running and OFF when a shut down occurs.
7. **Load switch** controls the filling of the dryer. The “ON” position initially fills the dryer. The “OFF” position turns the conveyor off/shuts the slide gate. The “AUTO” position enables automatic fill control and the OUT OF GRAIN TIMER.

On dryers filled on demand with a conveyor or slide gate:

In the “ON” or “AUTO” position the fill conveyor turns ON/slide gate opens when the dryer is low on grain and OFF/closes when the dryer is full. In the “AUTO” position only, the dryer will automatically shut down when the dryer is low on grain and the OUT OF GRAIN TIMER expires.

On choke filled dryers:

In the “AUTO” position only, the dryer will automatically shut down when the dryer is low on grain and the OUT OF GRAIN TIMER expires.

In the “ON” or “OFF” position the OUT OF GRAIN TIMER IS DISABLED. The LOAD switch is illuminated whenever the load conveyor is running.

8. **Low grain light** flashes when the grain level is low and the OUT OF GRAIN TIMER is running. The LOW GRAIN light is on steady when the timer expires.
9. **Blowers switch** turns the blower(s) ON or OFF. On multifan dryers, the blowers start sequentially. The lighted switch flashes during blower start-up. The switch is illuminated when all of the blower airflow switches close indicating that the blowers are operating correctly. After the closure of all of the airflow, the dryer automatically goes through a 30 seconds purge cycle.
10. **Burner switch** turns the burner ON or OFF. When the switch is turned ON, the burner pilot will automatically light, after the purging cycle is completed. The lighted burner switch will flash during the 15 seconds pilot ignition time. The switch illuminates when the pilot flame is sensed at the pilot. After the pilot flame is established the maxon shut off valves in the fuel train are energized. Motorized valves will automatically open to provide gas to the main burner. Manual valves must be opened manually to supply gas to the main burner.

3. Tower Dryer Operations and Service

11. **Unload conveyor switch** turns the dry grain unload conveyor ON or OFF. The switch illuminates when the conveyor is operating.
12. **Metering device switch** turns the metering device ON or OFF in forward or reverse. The device will not run unless the unload conveyor is ON. The switch illuminates when the metering device is discharging grain.
13. **Dryer power start button** initiates automatic operation of the dryer. When depressed, the dryer begins the start-up cycle and operates based on the positions of the selector switches on the control panel. To control the operation of individual components, first depress the DRYER POWER START button, then turn on the individual dryer components as desired.
14. **Dryer power stop button** manually stops all dryer functions and automatic equipment in a controlled shut down sequence.

IMPORTANT: *In case of an automatic dryer shut down, the DRYER POWER STOP button must be depressed before the dryer can be re-started.*

Dryer Start-Up

1. **Prepare dryer for start-up**

Perform pre-season inspection and service as outlined in the [Maintenance Section on Page 28](#) before attempting to operate the dryer. Make sure all discharge doors, grain exchanger clean-out doors, heat section door, louvered cooling section doors, etc. are closed. Make sure that all personnel are clear of the dryer and any grain handling machinery.



The dryer must have all pre-season and post-season maintenance to ensure reliable operation.

2. **Open main gas valve** to dryer.
3. **Switch on main breaker** to provide electrical power to the dryer by placing the main circuit breaker handle located on the dryer power panel to the “ON” position.
4. **Pull out both emergency stop buttons** located on the side of the control and power box to enable the main PLC circuit.
- 5.1 **Switch on the control panel** by turning the CONTROL POWER selector switch to the “ON” position. The switch will illuminate indicating that the control panel has power and is operating correctly. After a short series of self-diagnostic tests, the LCD display screen will display a copyright message and a start button.
- 5.2 **Press the on-screen Start button to enter the dryer status screen.**
6. **Press the DRYER POWER “START” button** to activate the LOAD, BLOWERS, BURNER, UNLOAD and METERING DEVICE selector switches on the control panel.
7. **Start auxiliary equipment** needed for filling dryer. (i.e. wet legs, conveyors, etc.)

3. Tower Dryer Operations and Service

8. **Fill the dryer** by turning the LOAD selector switch to the “ON” position. On a demand fill dryer, the wet conveyor will turn ON/slide gate will open and the dryer will start filling with grain. Once the dryer is full, a horn will sound and the wet conveyor will stop/slide gate will shut. Turn the LOAD selector switch to the “AUTO” position to silence the alarm and begin normal dryer operation. In the “AUTO” position, the dryer automatically controls the conveyor/slide gate and the OUT OF GRAIN TIMER is enabled, allowing automatic shut down if the dryer remains low on grain after a preset period of time.



The burner should be covered before filling the dryer to prevent accumulation of foreign material on the ignitor, flame sensor and burner ports. Foreign material may interfere with burner operation.

9. **Set drying/plenum temperature** by touching the P.L. Temp box on the LCD display. On the pop-up keypad that is displayed, enter the new drying temperature.

Recommended drying temperatures

Corn.....	180° to 210°F
Soybeans.....	140° to 160°F
Wheat.....	140° to 160°F
Milo.....	160° to 180°F
Barley.....	140° to 160°F
Oats.....	140° to 160°F

10. **Start the blower(s)** by turning the BLOWERS selector switch to the “ON” position. The blower(s) will automatically start. On multiblower units the PLC will automatically, start the blowers sequentially. Once the blower(s) are up to speed the air switches will close and the blower switch light will illuminate.

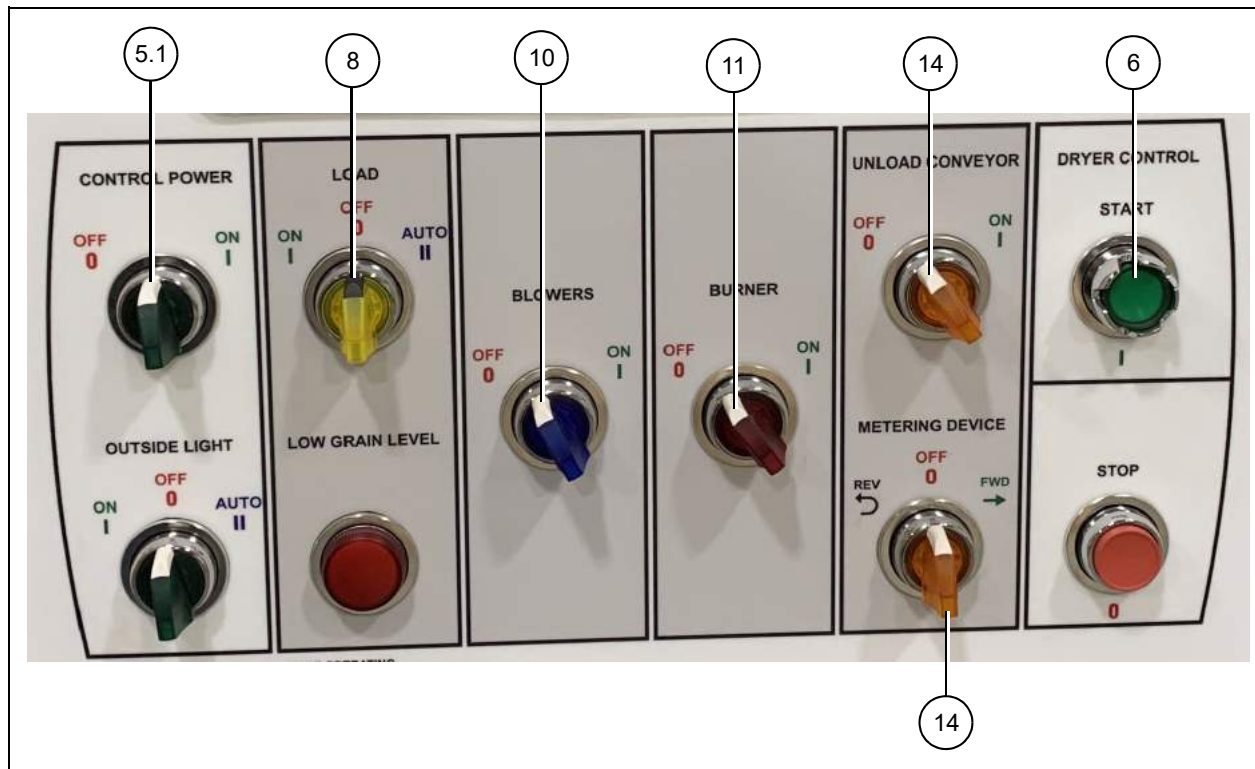

Figure 3C

3. Tower Dryer Operations and Service

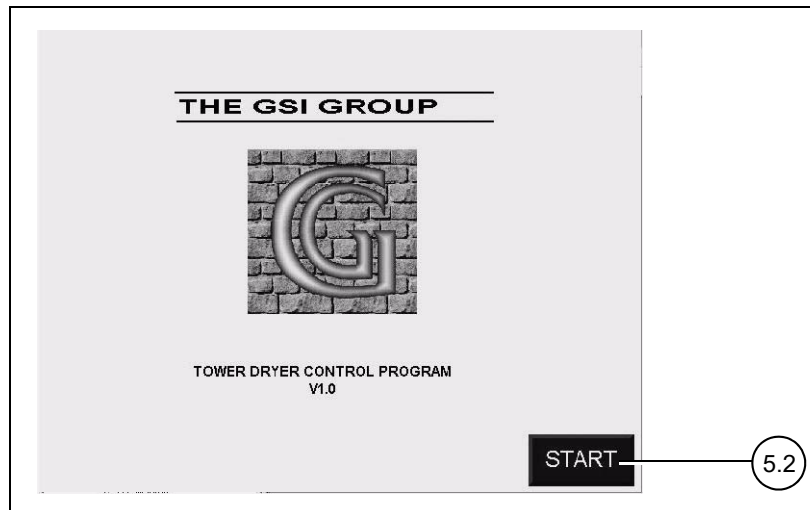

Figure 3D

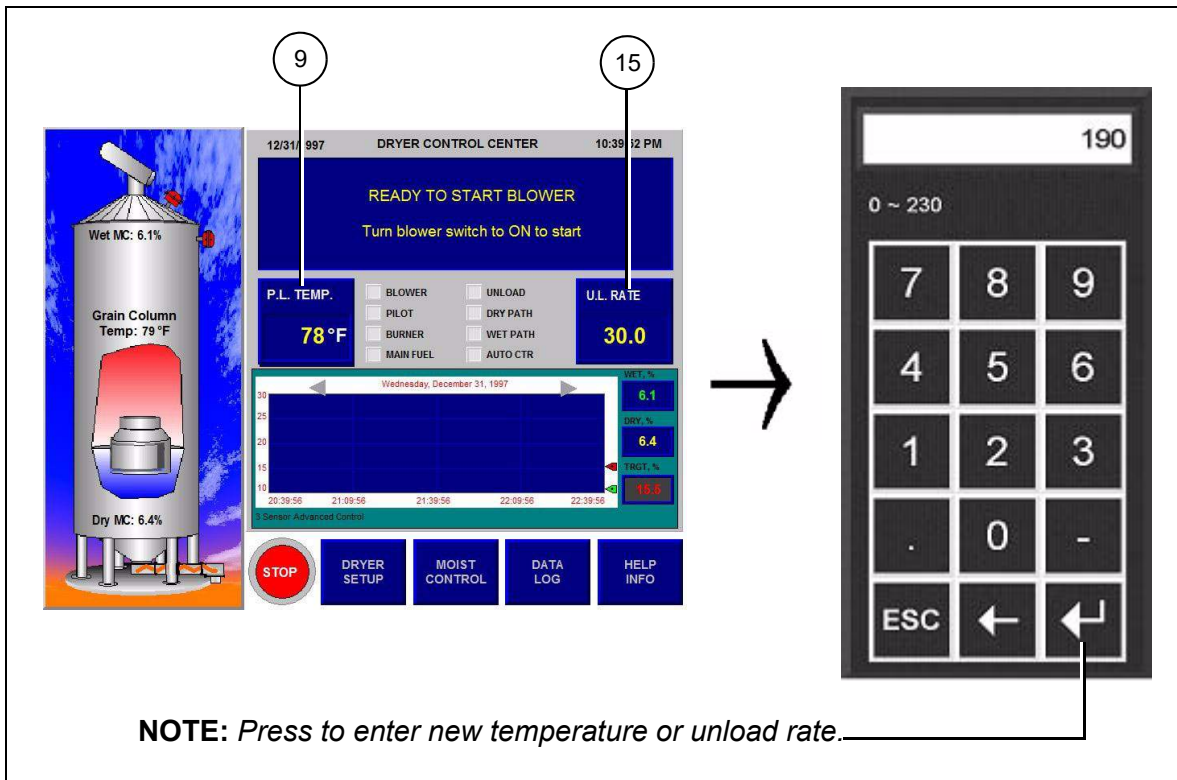

Figure 3E

11. **Start the burner** by turning the BURNER selector switch to the “ON” position. The dryer automatically goes through a 30 seconds purge period once the blowers are started. The amount of time remaining on the purge cycle will be displayed on the LCD display screen. After the purge period the burner pilot will automatically light. Once the flame control circuit on the dryer senses flame, the light in the BURNER selector switch will illuminate. If the pilot fails to illuminate in 15 seconds the burner will lock out and must be re-started by turning the BURNER switch “OFF” then back “ON”.

12. **Cock and open the maxon valves.** After the pilot is ignited, the main burner can be lit by cocking and opening the two maxon gas shut off valves. These valves will automatically open on dryers equipped with motorized maxon valves. The main burner will light and the dryer's plenum temperature will be automatically controlled by the modulating motor and maintained at the selected temperature.

12.1 **Open firing valve** (Canadian dryers only.)

13. **Let plenum come up to temperature and begin drying.** Depending upon ambient conditions, the dryer may take 10 minutes or more to reach the drying temperature.

14. **Start unload system.** Before discharging grain from the dryer, first make sure all dry legs and conveyors are operating ahead of the dryer. Turn the UNLOAD CONVEYOR selector switch to the "ON" position to operate the dry grain conveyor leading from the dryer. Turn the METERING DEVICE selector switch to the "FORWARD" position to start discharging grain from the dryer.



The metering device will not run unless the unload conveyor is also running.

15. **Set unload rate/moisture control temperature manually.** While operating the dryer in manual mode, set the unload rate by touching the U.L. Rate box on the LCD display. On the popup keypad, enter the new unload rate and press return.

16. **Check discharge moisture content** after 10 minutes. Take five small samples from the discharge and mix before taking a moisture reading.

17. **Switch over to automatic moisture control.** When the discharge moisture content has stabilized at the desired amount for 20 to 30 minutes, the dryer may be switched over to automatic moisture control.

17.1 Press the MOISTURE CONTROL button at the bottom of the LCD screen.

17.2 On the moisture control setup screen, set the upper and lower speed limits by touching the corresponding box and using the pop-up keypad. These values prevent the unload from moving too fast or too slow should the incoming moisture be significantly greater or less than anticipated.

17.3 Press the CONTROL MODE box to toggle between manual and automatic moisture control. Note that the current and target grain temperatures are displayed next to the temperature history chart.



If the discharge moisture content is consistently too high or too low, adjust the target grain temperature as follows:

5°F increase = 1 moisture point decrease

5°F decrease = 1 moisture point increase

Allow 30 minutes between adjustments.

3. Tower Dryer Operations and Service

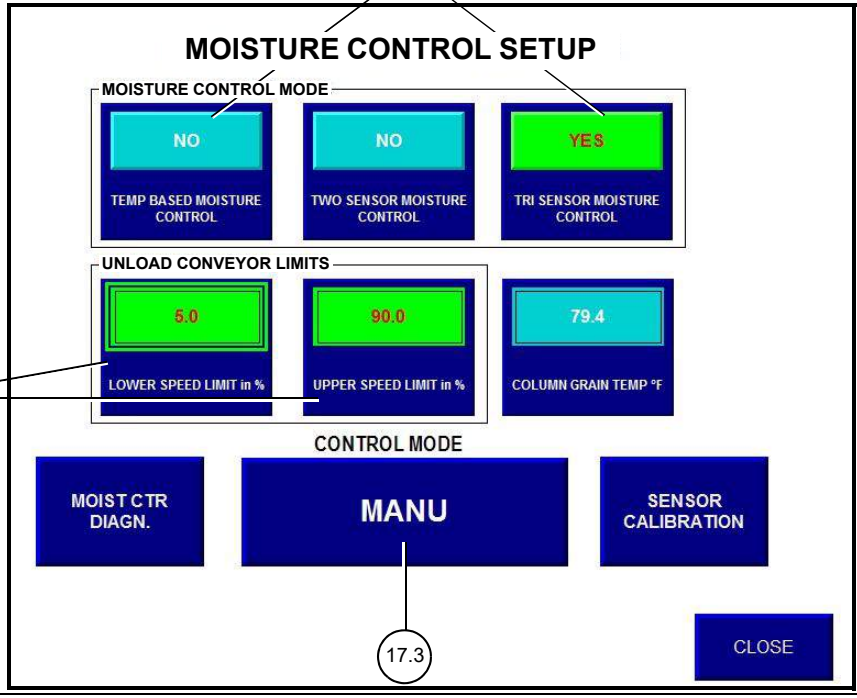
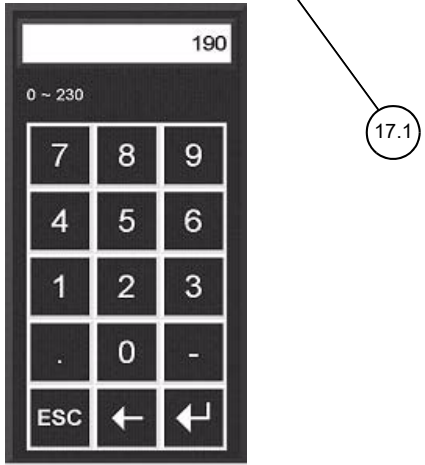
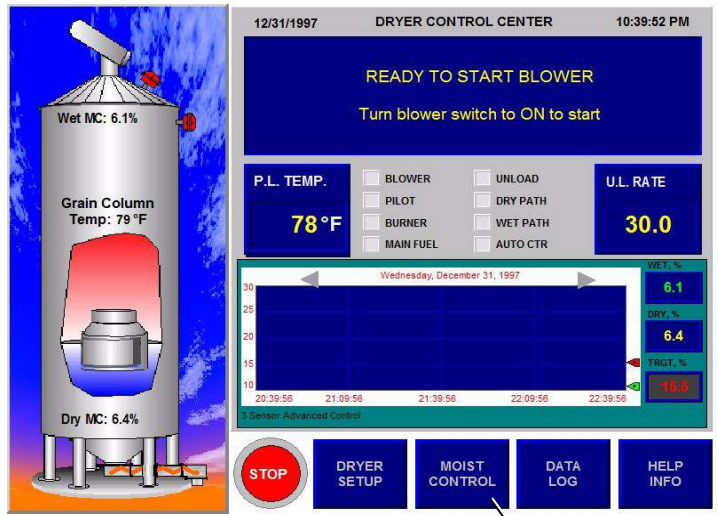

Figure 3F

- 18. Shut down dryer.** The dryer will likely have to be shut down from time to time. The steps used to shut it down will depend upon the duration of the shut down. If the dryer will be shut down for four hours or less, follow the short shut down procedure. For longer shut downs, such as overnight, follow the extended shut down procedure.

Short shut downs - Less than four hours

For short shut down periods, the dryer can be shut down by pushing the DRYER POWER STOP button. *To re-start the dryer, push the DRYER POWER START button. The PLC will re-start the dryer automatically based on selector switch settings.*

Extended shut downs - four hours or more

- 1. Shut off the burner.** Turn the BURNER selector switch to the "OFF" position. All gas valves will immediately close and the burner will extinguish.
- 2. Cool down grain.** PLC will continue to operate blowers to cool grain. To avoid overdried grain upon re-starting the dryer, continue to move grain through the dryer during the cooling off period.
- 3. Shut off unload equipment.** Turn METERING DEVICE and UNLOAD CONVEYOR selector switches to "OFF" position.
- 4. Shut off blowers.** Turn BLOWER selector switch to "OFF" position.
- 5. Shut off control panel.** Turn the CONTROL POWER selector switch to the "OFF" position.
- 6. Turn OFF main circuit breaker** located on the power panel.
- 7. Close main gas valve** to the dryer.
- 8. Inspect the inside of the dryer** after operation to ensure against the possibility of hot spots or fires.

Viewing Temperature/Moisture History

Press the left and right arrows above the temperature/moisture history chart to move backward and forward through the graph.

Viewing Burner/Fuel Train Status

Press the Burner region in the dryer view portion of the LCD display to switch to the fuel train status screen. This screen displays the open/closed state of all valves as well as the modulating valve control value.

Viewing Grain Flow Status

Press the unload region in the dryer view portion of the LCD display to switch to the grain flow status screen. This screen displays the running status of all controlled/interlocked equipment in the grain flow path.

Modifying the Bushel Per Hour Factor

The bushel per hour reading given by the PLC is a calculated value based on metering device speed. Due to variations in grain test weight and unload system settings, the correction factor may need to be calibrated so that the calculated and actual grain flow rates agree. The bushel per hour factor is normally set at 1.0. If, for example, the actual grain flow rate is 5% higher than displayed, change the bushel per hour factor to 1.05. To adjust the correction factor, press the DRYER SETUP button, then the BUSHEL COUNTER button. Press the CORRECTION FACTOR box to adjust the value.

4. Optional Tri-Point Moisture Controller

Main Screen

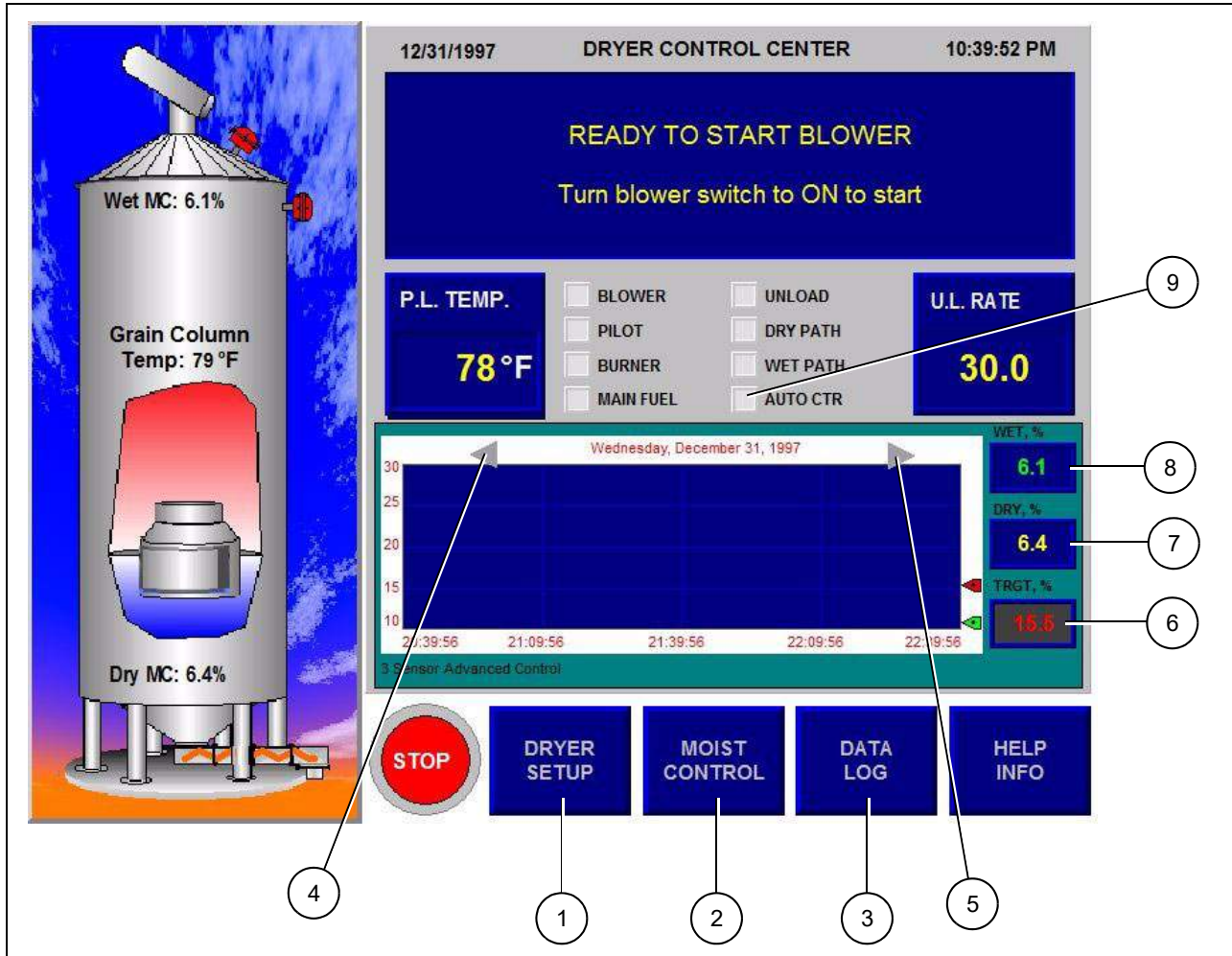

Figure 4A

1. **Two Hours moisture history chart** - Green line for incoming moisture, yellow line for outgoing moisture and the red line is the target moisture.
2. **Moisture Control Button** - To access the Moisture Control Set-Up screen.
3. **Data Log Button** - To access the moisture history data (up to last thirty (30) hours).
4. **Back Browse Button** - To scroll the chart back in time.
5. **Forward Browse Button** - To scroll the chart in forward time.
6. **Moisture Target** - To change the moisture target, press within the rectangular area and key in the new target from the pop-up keypad.
7. **Current moisture coming out of the dryer.**
8. **Current moisture coming into the dryer.**
9. **Moisture Control Status** - The LED turns ON if the moisture controller is in auto mode.

Set-Up of the Controller

*Press the “MOIST CONTROL” button from the main screen to access the moisture set-up screen:

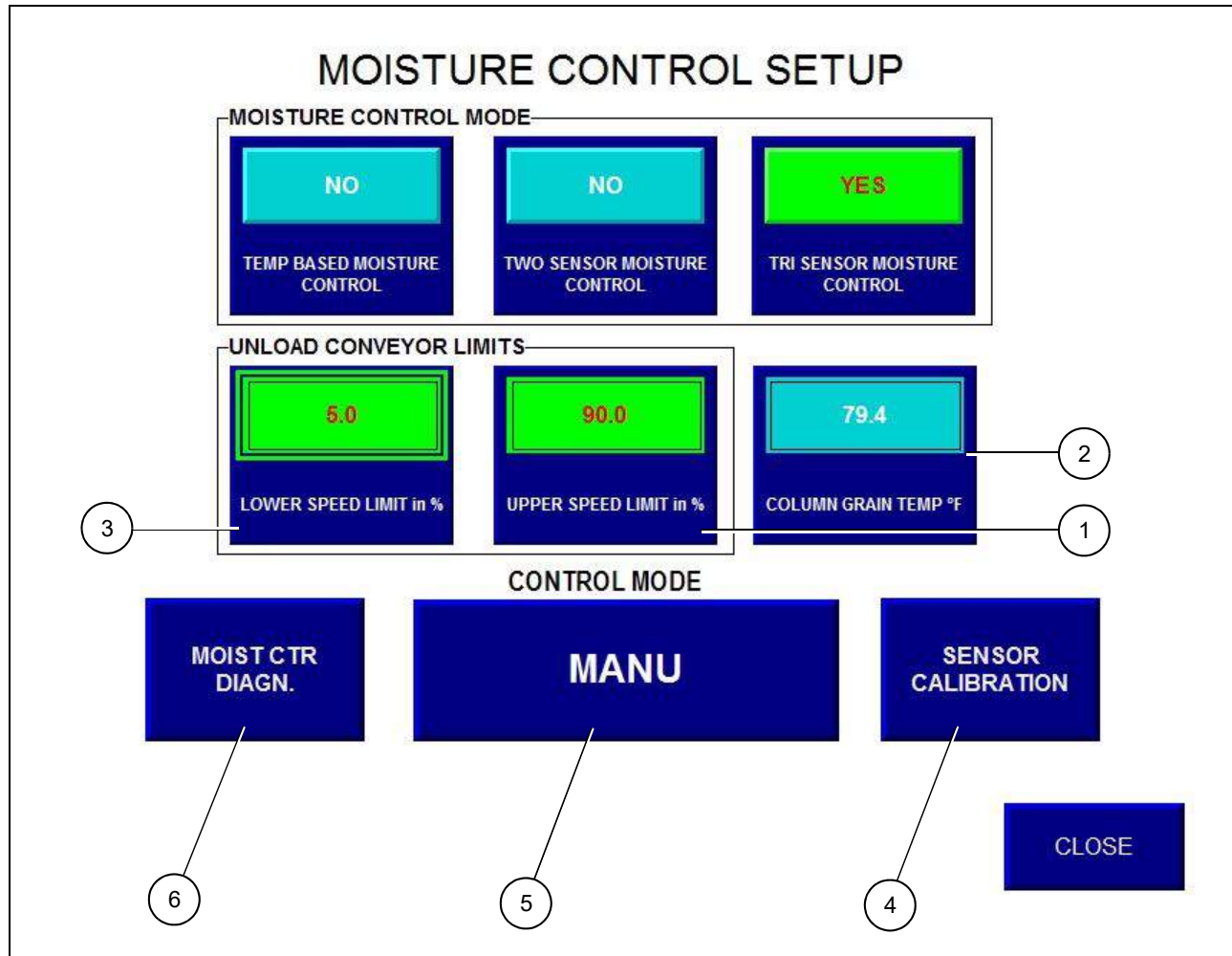

Figure 4B

1. **Unload Upper Speed Limit** - The maximum unloading rate (%) in which dryer can be run without plugging any unloading conveyors.
2. **Current Column Grain Temperature** - Measured from the RTD sensor at the end of the drying section. (It is not the temperature of the grain coming out of the dryer.)
3. **Unload Lower Speed Limit** - The minimum unloading speed that can maintain the sampling box of the dry sensor full of grain. It is essential to have the sensor fully covered by grain to get an accurate reading of the grain moisture.
4. **Sensor Calibration Button** - To access sensor calibration screen. *(See Step 3 on Page 24.)*
5. **Control Mode Button** - Toggle the control mode between MANUAL and AUTO by pressing the button.
6. **Moisture Control Diagnosis Button** - To access the diagnostic screen for factory troubleshooting.

4. Optional Tri-Point Moisture Controller

Operation Procedure

1. Start the dryer, set the dryer unload at a desired speed from the dryer control panel.
2. Let the dryer run under manual mode for warming up until the column grain temperature has stabilized and the moisture coming out of the dryer is within $\pm 2\%$ of the target moisture.
3. During the start-up period, calibrate both the wet and dry sensors against a bench meter as follows:
 - a. Press “**SENSOR CALIBRATION**” button from the moisture control set-up screen to open the sensor calibration screen.
 - b. Take grain samples from the dryer, measure the moisture with a bench meter and then compare to the sensor reading during the sampling period.

Change the sensor offset if the sensor reading does not match the bench measurement. For example, if the offset was 1.0% and the sensor reading is 0.5% lower than the bench meter, then change the offset to 1.5% to match the sensor to the bench meter. Likewise, if the sensor reading is higher than the bench meter, the offset should be decreased accordingly.



Figure 4C



The sensor should be calibrated 2-3 times a day. At the same time check and clean the sensor and sensor sampling box to make sure that there is no debris blocking the grain flow around the sensor.

4. Check or change the target moisture from the main screen.
5. Press “**MOIST CONTROL**” to access the moisture control set-up screen. Check upper/lower unloading limits and change them if needed.
6. Press the “**CONTROL MODE**” button from the moisture control set-up screen and set the mode to **AUTO**. The moisture controller will start adjusting the unload rate between the upper and lower limits of the unload speed to maintain the moisture coming out of the dryer.

How the Controller Works

The controller continuously monitors the moisture coming in and out of the dryer and the column grain temperature at the end of the drying section. The control action is mainly based on the dry sensor at the outlet of the dryer. If the moisture coming out of the dryer is not right at the target, the controller will speed up or slow down the unload device accordingly. The wet sensor and the column grain temperature sensor are intended to detect moisture spikes coming into the dryer so that the moisture controller can react ahead of time. For example, if the wet sensor detects a jump of moisture coming into the dryer, the controller will start slowing down the unload speed right away. However, the controller does not act to the full scale immediately. Instead, it slows down the dryer gradually so that the grain currently in the dryer will not be overdried too much.

In the first pass after the dryer started, the controller does not have enough information of the grain in the dryer. It controls the dryer by using the manual speed setting as a starting point. In other words, the manual speed setting is most responsible for the first pass of drying. Therefore, set the manual unloading speed as close as it should be for the grain currently in the dryer before switching to **AUTO** control mode. The manual speed setting does not have to be adjusted after the controller is switched into **AUTO** mode.

4. Optional Tri-Point Moisture Controller

Alarms

The controller checks the sensors and control status regularly. If abnormal conditions are detected, a corresponding alarm will go OFF, an alarm message will come up on the main screen **and the dryer will be shut down**.

Alarm	Causes	Solution
Moisture out of range - the moisture coming out of the dryer was 2.5% above or below the set point for more than one hour under AUTO control mode.	<ol style="list-style-type: none"> 1. Sensor box plugged and sensor was not covered by grain. 2. Dry sensor out of calibration. 3. Too big swing of moisture coming into the dryer. 	<ol style="list-style-type: none"> 1. Clear the sampler and sensor box. 2. Calibrate the sensor. 3. Run the dryer manually for one pass.
Dry sensor error - sensor reading is less than 6% or higher than 40%.	<ol style="list-style-type: none"> 1. Bad wiring. 2. Bad sensor. 3. Bad circuit board. 	<ol style="list-style-type: none"> 1. Check connection. 2. Change the sensor. 3. Change the circuit board.
Dry grain temperature out of range (0-300°F).	<ol style="list-style-type: none"> 1. Bad wiring. 2. Bad sensor. 3. Bad circuit board. 	<ol style="list-style-type: none"> 1. Check connection. 2. Change the sensor. 3. Change the circuit board.
Wet sensor error - sensor reading is less than 6% or higher than 40%.	<ol style="list-style-type: none"> 1. Bad wiring. 2. Bad sensor. 3. Bad circuit board. 	<ol style="list-style-type: none"> 1. Check connection. 2. Change the sensor. 3. Change the circuit board.
Wet grain temperature out of range (0-300°F).	<ol style="list-style-type: none"> 1. Bad wiring. 2. Bad sensor. 3. Bad circuit board. 	<ol style="list-style-type: none"> 1. Check connection. 2. Change the sensor. 3. Change the circuit board.
Column grain temperature RTD out of range (0-300°F).	<ol style="list-style-type: none"> 1. Bad wiring. 2. Bad sensor. 3. Bad circuit board. 	<ol style="list-style-type: none"> 1. Check connection. 2. Change the sensor. 3. Change the circuit board.

Access Drying History

1. Press the “**DATA LOG**” button from the main screen to open the moisture history screen.
The controller logs quarterly data up to 120 records (i.e. thirty (30) hours) into the archive.
2. Press the browse buttons to browse the record.

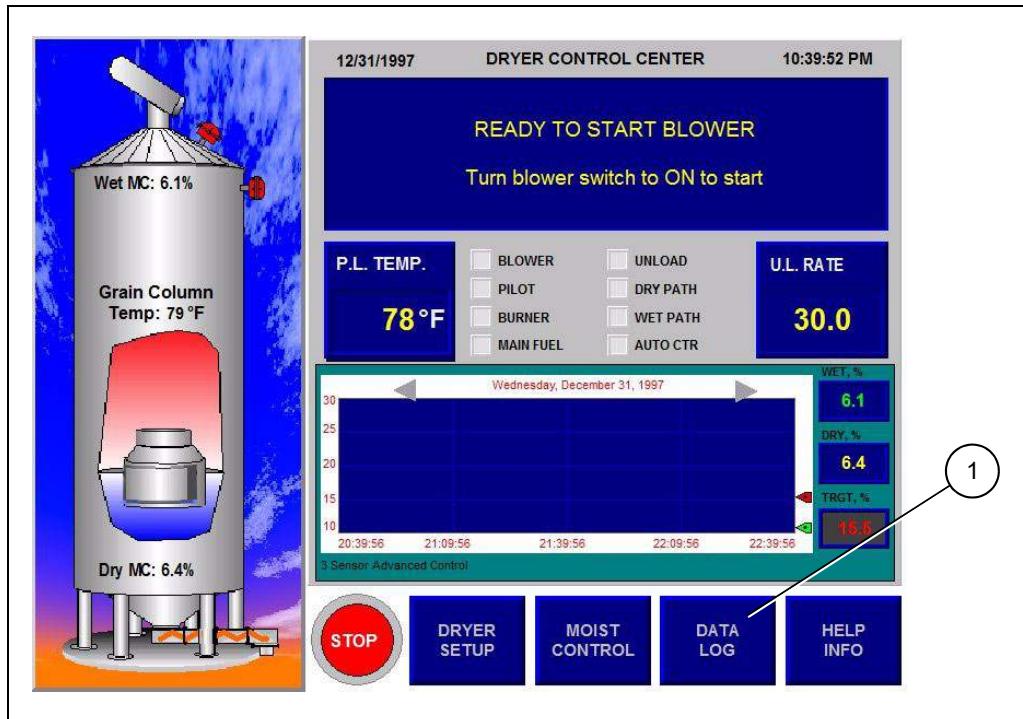

Figure 4D

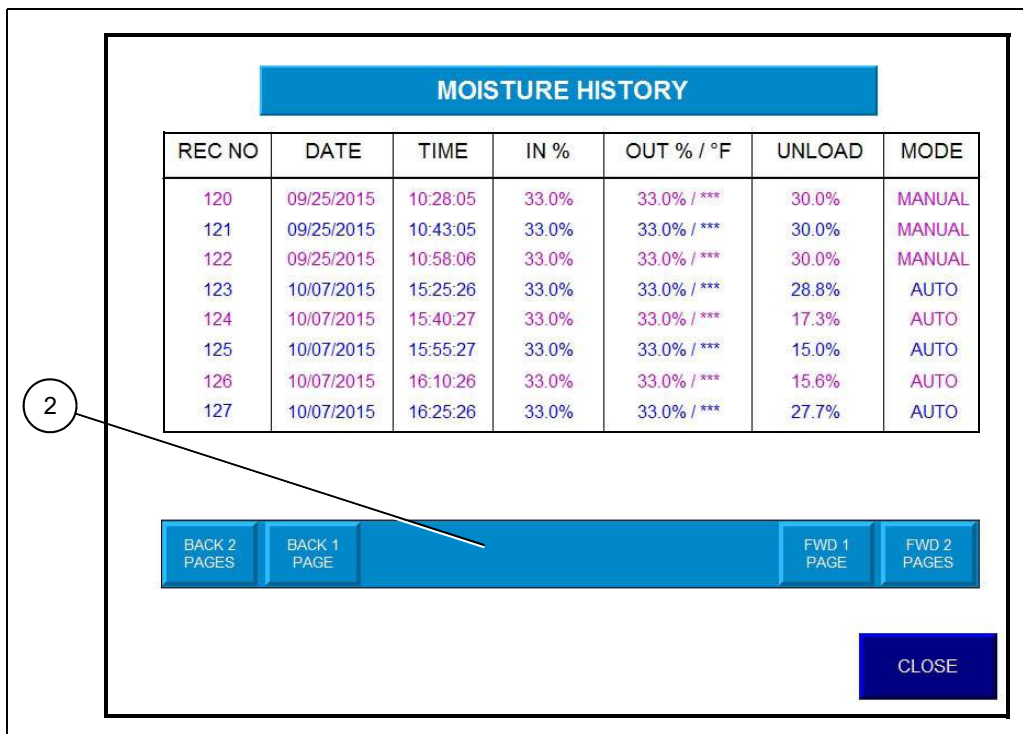

Figure 4E

Pre-Seasonal Inspection and Service

The dryer is made of weather-resistant material and is designed to require minimum service. However, each season we recommend the following items be checked before the unit is used and any damaged or questionable parts replaced. These checks will help eliminate possible failures and assure dependable operation of the equipment.

1. Shut off electrical power. Open power box and control box and inspect for moisture, rodent damage or accumulated foreign material present. Inspect and tighten any loose terminal connections. Replace any damaged or deteriorated wiring.
2. Lubricate the blowers, motors and metering system as outlined in the lubrication table [on Page 31](#).
3. Check blower belts for proper tension.
4. Inspect and clean the burner. Visually check that no holes in the stainless steel air mixing plates are plugged. If burner ports are plugged, clear them with a piece of wire or a drill bit. After a period of several years, it may become necessary to drill out the burner ports to clear away accumulated rust. Use a #43 drill bit to return burner ports to their original diameter. (See burner drilling procedure in the Maxon Burner area of the COMPONENT MANUALS section of this book.) (**NOTE: Pre-2002 model dryers require a #47 drill bit.**)
5. Check electrical connections at both the flame rod and spark plug. Clean spark ignitor and flame rod. Replace if necessary.
6. Check drain valve on gas train to ensure that there is no water in the gas train. Valve should always be open when the dryer is not being used. Ensure that drain valve is closed prior to dryer operation.
7. Lubricate linkage on gas modulating valve.
8. On **Zimmerman Dryers** equipped with the Accutrol sweep unload metering system, check the discharge area to ensure that the area is cleaned of stalks and old grain. Inspect the sweeps for excessive wear.
9. On **GSI Dryers** equipped with the hoppers metering system, check the hopper area and the area around the metering drum to ensure that they are cleaned of stalks and old grain. Check the edges of the metering drum for excessive wear.
10. **IMPORTANT:** *The covers to the discharge sections on both the Zimmerman and GSI Tower dryers must be in place and clamped down at all times when the dryer is in operation. If the cover is OFF during operation, the vacuum created by the blowers will suck foreign matter from the discharge area and deposit it in the heat section of the dryer plugging the inside screens of the dryer also creating a fire hazzard.*



See Pre-Season Service Checklist [on Page 32](#).

Seasonal Inspection and Service

1. **IMPORTANT:** *The covers to the metering system access door(s) must be in place at all times when the dryer is in operation. Before turning blowers always make sure this door is clamped into position.*
2. Follow lubrication guides as outlined in the lubrication table [on Page 31](#).
3. **Do not let grain fines and dust accumulate inside the cooling section of the dryer.** Bi-weekly if drying most products or daily if drying milo, clean the cooling chamber floor of fines and dust. Sweep down the cooling section sheets if necessary. Fines can be swept into the unload systems on both the Zimmerman and GSI dryers.
4. **Do not let grain fines and dust accumulate inside the heat section of the dryer.** Daily check the hopper divider that separates the heat section from the cooling section to ensure that it remains clean and open.
5. When cleaning dryer, check the grain discharge area on the dryer. On **GSI** hopper bottom dryers check around the metering drum to ensure that grain is flowing freely from each column and that there is no trash build-up. On **Zimmerman** Accutrol sweep dryers check the sweeps for trash or stalk build-ups that could be obstructing grain flow.
6. The dryer is not intended to be a grain storage structure. Storing grain in the dryer for extended periods of time can result in plugged grain columns, torn or stretched perforated dryer wall sheets, and can place undue structural stress on the interior rolled plenum channels that form the roundness of the dryer. During the drying season, if the dryer is only being operated occasionally, the metering system on the dryer must be operated for five minutes every other day to make sure that the grain in the drying columns remains loose and free flowing. If a weather event such as rain or snow storm occurs when the dryer is full of grain, the dryer must be operated the next day to make sure that the wet grain does not swell up in the drying columns.
7. When drying dirty corn in high humidity conditions, sludge may build up in the upper outside sheets of the dryer. This build up can be removed by either washing the sheets down with a high pressure water hose or by shutting incoming grain, dropping the grain level to below the plugged area and then running the fans and burner to dry the affected area. Tapping or sweeping the sheets will dislodge debris. Attempting to sweep off the sheet build-up while it is still wet will usually plug the sheet more.

In Case of Fire

1. When you first detect a fire, the entire drying operation should be shut down, including grain flow into and out of the dryer. The emergency controls may have already done this. Also, shut off the electrical and fuel supply to the dryer.
2. Do not try to cool a fire by running fan(s).
3. Never run grain from the dryer into the elevator or storage if a fire is known or suspected.
4. Locate the area of the fire.
5. If the fire can be extinguished with a fire extinguisher, water hose or by removing the burning material, this should be done right away. Watch the dryer closely for another fire after one has occurred.
6. Emergency discharge slide gates at the bottom of each column as well as easy access gates located near the hopper discharge area permit fast dumping of each individual grain column. If it is necessary to emergency dump grain from the dryer, wait until the fire department is onsite before doing so.
7. A fire extinguisher should be located at or near the dryer, if a fire seems to be getting out of control call the fire department.

5. Maintenance

End of Season Service

1. Empty the dryer at the end of the drying season. The dryer must not be used for grain storage. Grain left in the dryer will compact, can become wet, swell, and/or spoil. This can result in plugged grain columns, torn or stretched perforated dryer wall sheets, and can place undue structural stress on the dryer's interior rolled plenum channel rings.
2. Clean out the plenum roof grain cushion and remove any grain that may be hanging up on the plenum roof.
3. Make sure the grain exchangers are clean.
4. Clean out the hopper that divides the heat section from the cooling section.
5. Clean the cooling chamber floor.
6. Remove all grain and trash from the metering drum floor. This grain can be raked out by hand by opening the slide gates located in the hopper bottom of the dryer.
7. Make sure gas supply is shut off to the dryer.
8. Open the gas train drain valve located on the bottom of the gas train.
9. It is a good practice to cover the burner with a tarpaulin or plastic to ensure a clean burner.

Lubrication Table

Location	Instructions	Type of Lubrication	Lubrication Interval
Metering drum drive shaft bearing (On GSI hopper bottom dryers only) .	Lubricate slowly until lube shows through seal. Wipe clean.	High quality, grade #2 lithium based grease.	Beginning of season (annually).
Accutrol (sweep unload) top and bottom drive bearings. (On Zimmerman flat bottom dryers only) .	Lubricate slowly until lube shows through seal. Wipe clean.	High quality, grade #2 lithium based grease.	Beginning of season (annually).
Accutrol (sweep unload) coupling hub. (On Zimmerman Dryers) .	Remove the two lube plugs from the cover. Lubricate slowly until grease begins seeping through relief plug.	High quality, grade #2 lithium based grease.	Beginning of season (annually).
Blower shaft bearings. (Both GSI and Zimmerman Dryers) .	Lubricate bottom bearing plug slowly counting the grease gun pump until lube shows through the seal. Wipe clean. Use same # of grease gun pumps for top bearing.	High quality, grade #2 lithium based grease.	Every four weeks of dryer operation.
Blower motor bearings (Both GSI and Zimmerman Dryers) .	See motor lubrication procedure below ¹ .	High quality, grade #2 lithium based grease.	Every two years (Normal operation, ever 8-10 months continuous operation.)
Metering variable speed drive motor (Both GSI and Zimmerman Dryers) .	See motor lubrication procedure below ¹ .	High quality, grade #2 lithium based grease.	Every two years (Normal operation, ever 8-10 months continuous operation.)
12' Diameter Accutrol gearbox (12' diameter sweep unload gearbox) (Zimmerman Dryers only) .	Grease filled gearbox. Replenish grease to the first 1 st stage (upper) reduction mechanism through grease fitting provided (typically quantity= 0.3 oz. of grease.	High quality, grade #2 lithium based grease.	Beginning of season (annually). (Change grease in box every 3-5 years.)
18' and 24' Diameter Accutrol gearbox (18' and 24' diameter sweep unload gearbox) Zimmerman Dryers only) .	Oil filled gearbox with oil pump. Maintain oil level to upper red line on oil level gauge.	ISO VG 100 to 150 mineral based oil. AGMA Viscosity Grade 3EP to 4EP. (Mobilgear 627, 629 or equivalent).	Beginning of season. (Change every two years.)
Metering drum gearbox. (On GSI hopper bottom dryers only) .	Fill to check plug.	ISO VG 220 mineral-based oil. AGMA Viscosity Grade 5EP. (Mobilgear 630 or equivalent).	Beginning of season. (Change every 10,000 hours or two years.)
¹ Lubrication of motors - Operate motor for 20 minutes. Clean grease fitting. Remove grease relief plug and using a low pressure grease gun, pump in the required grease. After relubricating, allow motor to run for 10 minutes before replacing relief hardware. Do NOT overgrease.			

5. Maintenance

Pre-Season Service Check List

- Lubricate blower bearings.
- Lubricate blower motor bearings, if needed.
- Check blower belts and adjust if necessary.
- Clean burner ports.
- Inspect flame rod and spark ignitor.
- Check oil levels in gearboxes.
- Inspect divider hopper between heat and cooling section. Clean if necessary.
- Inspect Bindicator grain level switches.
- Inspect metering system access door cover seals.
- Lube metering system access door cover hold down latches.
- Lube Modutrol motor linkage.
- Check butterfly operation in modulating valve.
- Check gas pressure gauges.
- Check interior of Maxon shut off valves for corrosion. Clean if necessary.
- Clean control and power panels, tighten loose connections and check for leaks.
- Inspect metering systems. Clean accumulated stalks and old grain.
- Start-up dryer and check operating controls.
- Other: Itemize _____

End of Season Shut Down Procedure

- Start unload and empty all grain from dryers.
- Clean out grain cushion (on plenum roof under fill spout). Clean plenum roof.
- Clean off grain exchangers.
- Clean out divider hopper, between heating and cooling section.
- Clean inside cooling sheets and cooling floor.
- Remove all grain and trash from unload section of dryer.
- Open emergency grain discharge doors (and drain doors in Zimmerman dryers).
- Open drain valve in gas train.
- Cover burner with a tarp or plastic sheeting.

The GSI and Zimmerman Tower dryers are designed to be self diagnosing. Most electrical or operating problems are displayed on the screen of the operator interface and the problem area is graphically high lighted. Always ensure that either 240 or 480 volt 3 phase power is being provided to the dryer. All motor starters coils and the burner circuitry operate at 120 VAC. All of the safety circuit on the dryer operates at 24 VDC.

Listed below are potential troubleshooting issues associated with the dryer and possible solutions to the problems.

Drying Issues

Problem	What to do
Low dryer capacity.	Check to make sure the dryer is always full of grain.
	Check all grain columns to make sure they are all moving.
	Check outside dryer screen for dirt build-up. Clean if necessary.
Grain moisture discharges too wet.	Reduce unload rate.
	Or increase drying temperature.
Grain moisture discharges too dry.	Increase unload rate.
	Or decrease drying temperature.
Grain moisture discharges inconsistently.	Check that plenum temperature is being held consistent.
	Check for widely varying incoming moistures.
	Check for plugged grain columns.
	Verify that an adequate supply of grain is being provided to the dryer to maintain a grain seal within the dryer.
Burnt or scorched kernels appear during drying.	Some varieties of grain or frost damaged grain are sensitive to higher drying temperatures. Lower drying temperatures.
	If dryer is equipped with an external LP vaporizer, ensure that liquid propane is not passing through the vaporizer and going to the dryer.
Grain not moving through grain columns.	Check the dryer for fines build-up within the column. Empty if necessary.
	Do not leave the dryer full for extended periods of time or during rainy weather without occasionally moving grain through it.

6. Troubleshooting

Burner

Problem	What to do
Pilot will not light.	Check to see that the gas shut off valve is open.
	Verify that gas is being provided to the dryer by checking the pressure gauge located in the pilot line.
	Verify that the pilot solenoid is opening by listening for a "clicking" sound.
	Remove the pilot line from the pilot solenoid with the dryer turned OFF to verify that no water is in the pilot line. Blow the pilot line out with compressed air.
	Before re-attaching the pilot line attempt to light the pilot with the line removed. Gas should be flowing from the pilot solenoid.
	If gas is flowing, re-attach the pilot line and adjust of flow of gas by adjusting the pilot regulator.
	If pilot still does not light, check pilot area on burner. Clean if necessary.
	If pilot area is hot indicating that the pilot was lighting, replace flame rod.
	If pilot area is cold, replace spark plug.
	If pilot still does not light, check the Protectofier components in the control box.
Pilot lights but main burner will not light.	Check for water in gas train by opening drain valve.
	Maxon valve should offer some resistance when opening. If it does not, check latching solenoid inside Maxon valve.
	Check for broken or bent butterfly valve.
	Check to make sure burner ports around the pilot are clean.
Dryer will not reach operating temperature.	Increase gas pressure on main gas regulator.
	Make sure dryer is completely full of grain.
	Gas ports on burner need to be drilled. Clean by using a #43 drill bit.
	Check to make sure butterfly valve is fully opening.
	Check for water in gas train by opening drain valve.
Plenum temperature fluctuates.	Gas pressure is too high. Lower gas pressure on main gas regulator.
Dryer loses flame at regular intervals while running.	Loose or dirty flame rod. Clean and/or tighten.
	Defective Protectofier SS3CP transformer in control box. Replace.
Modulating Valve does not open.	Check to see that Maxon shut off valves are open.
	Check to see that the plenum set point temperature is higher than the ambient temperature.
	Check to see that 120 VAC is being provided to the black and white wires in the modutrol motor.
	Check the operation of the modutrol motor by momentarily jumping the "F" and "-" terminals in the motor to see if the motor will open.

General

Problem	What to do
Control power switch will not light.	Check to see that main circuit breaker in power box is ON.
	Check 2-pole circuit breaker for transformer.
	Check circuit breaker "CB-04" in power box.
OIU fails to light.	Check to see that main circuit breaker in power box is ON.
	Check 2-pole circuit breaker for transformer.
	Check circuit breaker "CB-04" in power box.
Dryer shuts down, red light lights and horn sounds, display shows: "OVERHEAT AT PLENUM" "POSSIBLE FIRE"	Check for possible fire in heat section of dryer.
	Make sure the plenum hi-limit control is set at least 30° above the desired drying temperature.
	Check for a malfunctioning gas train component that could be causing excessive plenum temperatures.
Dryer shuts down, red light lights and horn sounds, display shows: "OVERHEAT AT _____" "POSSIBLE FIRE"	Check for possible fire in dryer at location indicated in message.
	Check for a plugged or slow moving grain column.
	Check for a plugged grain turner.
	Check to ensure that the dryer is full of grain and is continually being kept full.
	Check for a defective hi-limit sensor.
OIU displays message: "UNLOAD DRIVE FAULT"	Indicates that the metering system inverter drive has tripped.
	Check for plugged metering drum or Accutrol metering system.
	Reset drive by turning OFF the main circuit breaker for 15 seconds or by pressing the "STOP" button on the inverter.
OIU displays message: "CONTACT FAILED TO CLOSE" "DRY CONVEYOR" -or- "WET CONVEYOR" -or any auxiliary starter	Indicates that any overload has occurred in the item indicated.
	Reset the overload of the starter indicated in the power panel and fix the overloaded conditions.
OIU displays message: "OVERLOAD TRIPPED" "BLOWER __ STARTER"	Indicates that overload has occurred in the blower indicated.
	Reset the overload of the starter of the blower indicated and fix the overload conditions.
	Blower overload can be caused by overly tightened blower belts or inadequately greased blower bearings.

6. Troubleshooting

OIU (Screen) Messages

Message	What to do
Overheat at top left possible fire	Check overheat condition and Terminal 011
Overheat at top right possible fire	Check overheat condition and Terminal 012
Overheat at middle left possible fire	Check overheat condition and Terminal 013
Overheat at middle right possible fire	Check overheat condition and Terminal 014
Overheat at lower left possible fire	Check overheat condition and Terminal 015
Overheat at lower right possible fire	Check overheat condition and Terminal 016
Overheat at inside left possible fire	Check overheat condition and Terminal 017
Overheat at inside right possible fire	Check overheat condition and Terminal 020
Overheat at plenum possible fire	Check overheat condition and Terminal 021
Overload tripped blower 1 starter	Check Terminal 051
Overload tripped blower 2 starter	Check Terminal 052
Overload tripped blower 3 starter	Check Terminal 053
Overload tripped blower 4 starter	Check Terminal 054
Auxiliary stuck closed blower 1 starter	Check Terminal 031
Auxiliary stuck closed blower 2 starter	Check Terminal 032
Auxiliary stuck closed blower 3 starter	Check Terminal 033
Auxiliary stuck closed blower 4 starter	Check Terminal 034
Auxiliary contact failed to close blower 1 starter	Check Terminal 031
Auxiliary contact failed to close blower 2 starter	Check Terminal 032
Auxiliary contact failed to close blower 3 starter	Check Terminal 033
Auxiliary contact failed to close blower 4 starter	Check Terminal 034
Switch open air pressure switch 1	Check Terminal 035
Switch open air pressure switch 2	Check Terminal 036
Switch open air pressure switch 3	Check Terminal 037
Switch open air pressure switch 4	Check Terminal 056
Switch open air pressure switch of combustion blower	Check Terminal 027
Lost flame	Check BCU and Terminal 026
Switch stuck closed maxon valve	Check Terminal 025
Flame detected while burner is OFF	Check if pilot or Maxon valves stuck open and check flame rod, BCU and Terminal 026
High gas pressure switch open	Check Terminal 023
Low gas pressure switch open make sure main gas valve is ON	Check gas pressure and Terminal 022
High gas pressure switch open gas pressure too high	Check Terminal 023
Low gas pressure switch open gas pressure too low	Check Terminal 022
Maxon valves not turn ON	Reset and try again

Message	What to do
Plenum temperature RTD circuit open or shorted	Check the RTD wiring
Grain temperature RTD circuit open or shorted	Check the RTD wiring
Auxiliary stuck closed oil pump starter	Check Terminal 057
Auxiliary stuck closed combustion blower starter	Check Terminal 060
Auxiliary contact failed to close oil pump starter	Check Terminal 057
Auxiliary contact failed to close combustion blower starter	Check Terminal 060
Plug switch open dry path plugged	Clear dry path and check Terminal 061
Plug switch open hopper plugged	Clear hopper and check Terminal 062
Unload drive fault	Check the drive and Terminal 040
Overload tripped dry conveyor	Check Terminal 055
Plug switch open wet path plugged	Clear wet path and check Terminal 063
Auxiliary stuck closed dry conveyor	Check Terminal 041
Auxiliary stuck closed auxiliary dry conveyor	Check Terminal 042
Auxiliary stuck closed dry leg	Check Terminal 043
Auxiliary stuck closed TopDry conveyor	Check Terminal 044
Unload monitor proximity switch open	Check the unload device and Terminal 065
Auxiliary stuck closed auxiliary wet conveyor	Check Terminal 047
Auxiliary stuck closed wet leg	Check Terminal 046
Auxiliary stuck closed top wet conveyor	Check Terminal 045
Contact failed to close dry conveyor	Check Terminal 041
Contact failed to close auxiliary dry conveyor	Check Terminal 042
Contact failed to close dry leg	Check Terminal 043
Contact failed to close TopDry conveyor	Check Terminal 044
Contact failed to close auxiliary wet conveyor	Check Terminal 047
Contact failed to close wet leg	Check Terminal 046
Contact failed to close top wet conveyor	Check Terminal 045
Indicator error UBS closed while LBS still open	Check Terminal 066 and 067
Shut down out of grain occurred at — Dry sensor error moisture signal out of range	Check the sensor wiring
Dry sensor error grain temperature signal out of range	Check the sensor wiring
Wet sensor error moisture signal out of range	Check the sensor wiring
Wet sensor error grain temperature signal out of range	Check the sensor wiring
Column grain RTD sensor error RTD out of range	Check the sensor wiring
Shut down by moisture controller failed to maintain to the target	Try again with close supervision
Ready to start	Press the dryer control START
Ready to start blower	Turn blower switch to ON to start
Ready to start burner	Turn burner switch to ON to start

6. Troubleshooting

Message	What to do
Out of grain	Will shut down in ___ seconds
Start unload now	Or will shut down ___ seconds
Dryer cooling off current grain temperature = ____	Blower will shut down in ____ secs/*N:5 or turn the blower switch OFF to shut down now.
Wet path not ON	Turn load switch to MAN or AUTO to start
Filling the dryer	Please wait...
Dryer is full	Press control STOP button to reset alarm then press control START button to re-start
Emptying the dryer	Please wait...
No power to SLC Start checking please wait ___ seconds left Tri-start on ___ seconds left Starting blower 1 Starting blower 2 Starting blower 3 Starting blower 4 Purging ___ seconds left Open main fuel valves or will shut down in ___ seconds Ignition trial ___ seconds left	Pull E-STOP button out and check Terminal 010 for 24VDC
Firing valve limit switch open the firing valve Interlocked start dry conveyor first Interlocked start auxiliary dry conveyor first Interlocked start dry leg first Interlocked start TopDry conveyor first Interlocked start auxiliary wet conveyor first Interlocked start wet leg first Interlocked start top wet conveyor first	Check Terminal 024

Commercial Tower Dryer Common Service Parts

Bindicator

Part #	Description	Where Used
GT3-0036	Bindicator, RXA-H-AX14AD00 120V Complete	Low grain indicator located on upper sidewall of dryer.
GT3-0037	Bindicator, RXA-H-AX13AD00 120V Complete	High grain indicator located on dryer roof.
756-1150-9	Bindicator Micro Switch	Replacement switch for either bindicator.
769-1225-2	Bindicator Paddle	Replacement paddle for either bindicator.
756-1148-3	Bindicator Motor A-H9A-K-HD	Replacement motor for either bindicator.
S-8896	Screw, MS #4-40 x 1" SHCS	Connects extension shaft or paddle to bindicator.
S-9100	Nylock Nut #4-40 ZN Grade 2	Connects extension shaft or paddle to bindicator.
769-1038-9	Bindicator Cover Gasket	Replacement gasket for either bindicator.
GT1-1119	Bindicator Extension Rod 12"	Standard extension rod for RA6 bindicator.
GT1-1473	Bindicator Extension Shaft 18"	Special length extension rod for RA6 bindicator.
GT1-1120	Bindicator Extension Rod Shield	Standard length rod shield (conduit) for RA6 bindicator.
GT1-1474	Bindicator Extension Shield 18"	Special length rod shield (conduit) for RA6 bindicator.
806-1667-5	Bindicator Conduit Cap	Rod shieldcap for RA6 bindicator.
769-1039-7	Bindicator Mounting Plate	Replacement mounting plate for RA4 bindicator.

Hi-Limits (Fixed and Adjustable)

Part #	Description	Where Used
GT3-0004	Hi-Limit, Fixed 210° 36' Fixed	Replacement Hi-Limit for Outside or Inside Overheats
756-1026-1	Thermostat, Hi-Limit Honeywell T675A 1102 160 to 260D Adjustable	Adjustable Plenum Hi-Limit that Monitors the Burner

RTD, Thermowells, Probes and Moisture Sensors

Part #	Description	Where Used
756-1865-2	Grain Temperature Probe 12"	Temperature based moisture probe mounted in outside sidewall about 1/3 the way up the dryer.
756-1866-0	Thermowell 12"	Thermowell to protect moisture probe.
815-1383-0	RTD Probe Mount Weldment	Mount for above thermowell and probe.
GT3-0139	Wire, 18/2 Shielded	Cable used for either probe above - sold per foot
GT4-1659	Moisture Sensor Assembly for D04-1418 - 32' Cable	Top or bottom sensor for tri-moisture system.
WR-CAT5E-SH	Cable, Wire CAT5E Shielded	Cable used for tri-moisture sensor - sold per foot
GT1-1534	Gate, Slide 2-1/4" - Moisture Sensor Box	Replacement slide gate for moisture sensor housing.
801-2143-7	Gate, Slide 2-1/2" - Moisture Sensor Box	Replacement slide gate for moisture sensor housing.
801-2144-5	Gate, Slide 2-3/4" - Moisture Sensor Box	Replacement slide gate for moisture sensor housing.
801-2101-5	Gate, Slide 3" - Moisture Sensor Box	Replacement slide gate for moisture sensor housing.

7. Parts List

Burner Control/Maintenance

Part #	Description	Where Used
756-1009-7	Flame Rod	Senses flame in burner (Natural gas or LP).
GT3-0091	Ignitor I-31-1 Spark	Spark plug for burner (Natural gas or LP).
WR-7MM	Wire, 7 mm Silicone Ignitor	Wire for spark plug - sold per foot
GT3-0609	Ignitor Plug Oil (Maxon GP18110/Auburn I-101)	Spark plug for burner (Fuel oil only).
756-1484-2	Connector, Flame Rod and Ignitor	Connector for spark plug or flame rod.
756-1485-9	Boot, Flame Rod and Ignitor	Rubber boot to cover connector on spark plug or flame rod.
801-2078-5	Pilot Hood	Mounts on burner above pilot area to prevent flame from "dancing" around.
145-1351-9	5/64" x 6" Burner Bit Long Boy	Used to drill out clogged burner (Natural gas or LP only).

Protection Controls Parts

Part #	Description	Where Used
GT3-0134	Flame Pac SS100	Component on burner board.
GT3-0136	Relay ACF	Component on burner board.
KD-PEC0020	Transformer SS3CP	Component on burner board.
GT3-0016	Protectofier Chassis 6642-VA	Complete burner board.
769-1378-9	Component Tester	Tester for burner board components.
GT3-0535	Scanner UV PCII W - Straight	Senses flame in burner - Straight (fuel oil only).
GT3-0450	UV Scanner PCII WRA - Right Angle	Senses flame in burner - Right angle (Fuel oil only).
GT3-0448	Brown Fiber Nipple	Fuel Oil Burner

Honeywell

Part #	Description	Where Used
GT3-0083	Motor Modutrol M7284A-1012	Mounted at end of gas train on top of CV valve - Controls gas flow to burner.
756-1002-2	Modutrol Motor Linkage	Links modutrol motor to CV valve.

Gearboxes and Parts

Part #	Description	Where Used
GSI Only		
GT3-1038	Gearbox, Sumitomo C6145Y 90:1 Ratio	Runs Metering Drum
GT3-0138F	Motor 5 HP 184TC Inverter Duty	Runs Metering Drum
GT1-0670	Plate, Metering Drum Sweep - SS	Leading edge plate for metering drum.
GT1-0671	Clip, Metering Drum Sweep	Clip to connect leading edge to metering drum.
Zimmerman Only		
717-1493-5	Gearbox, Sumitomo 6145 731:1 Ratio	Runs Metering System (12' Diameter Dryers Only).
702-1069-5F	Motor, 1 HP 3 PH 1725 RPM 60 Hz Super	Runs Metering System (12' Diameter Dryers Only).
717-1371-3	Gearbox, Sumitomo 6185DB 1003:1	Runs Metering System (18' Diameter Dryers Only).
702-1068-7F	Motor, 1-1/2 HP 3 PH 1725 RPM 60 Hz with Thermostat	Runs Metering System (18' Diameter Dryers Only).
717-1440-6	Gearbox, Sumitomo 6195DA 1505:1	Runs Metering System (24' Diameter Dryers Only).
702-1067-9F	Motor, 2 HP 3 PH 1725 RPM 60 Hz Super	Runs Metering System (24' Diameter Dryers Only).
GT3-1024	Gearbox, Sumitomo CVVJ6205DAY 1247:1 Ratio	Runs Metering System (30' Diameter Dryers Only).
702-1047-1F	Motor, 3 HP 3 PH 1725 RPM 60 Hz Super	Runs Metering System (30' Diameter Dryers Only).
GT1-1458	Agitator Weldment	Mounts to back of sweep to agitate grain under column.

Manual Shut Off Valves

Part #	Description	Where Used
GT3-0014	Valve, Ball Manual 2"	Used at beginning of gas train - Size specific.
GT3-0198	Valve, Ball Manual 3"	Used at beginning of gas train - Size specific.
707-1141-1	O-Ring 2" Dezurich	Replacement part for 2" Dezurich valve.
707-1140-3	O-Ring 3" Dezurich	Replacement part for 3" Dezurich valve.
D02-0084	Brass Ball Valve 1/4"	Used in return line back to regulator as balancing valve.
D03-0837	Brass Ball Valve 3/4"	Used in gas train (LP dryers).
TFC-0093	Valve, 1" NPT Bronze Ball - CGA Approved	Used in gas train (LP dryers).

ASCO Solenoids

Part #	Description	Where Used
GT3-0034	Valve, ASCO 3/8 NC 120 V/60 Hz (Pilot)	Gas Train Pilot Solenoid
GT3-0719	Solenoid Valve 1-1/4"	Gas Train Solenoid between Dual Maxons
TF-1536	Solenoid Valve 1-1/2"	Gas Train Solenoid between Dual Maxons
GT3-1232	Solenoid Valve 3/4" Liquid (LP)	Gas Train Solenoid (LP Oil Only)

Pressure Gauges

Part #	Description	Where Used
707-1694-9	Pressure Gauge 30 Oz.	Used in gas train after CV valve.
GT3-0131	Pressure Gauge 20 Oz.	Used in gas train after CV valve.
HH-2984	Pressure Gauge 30 Lbs.	Used in gas train for incoming pressure.
D02-0103	Pressure Gauge 8-100 Lbs.	Used in gas train (LP dryers only).
GT3-0671	Gauge Pressure 2-1/2" Liquid Filled 200 PSI	Used in gas train (LP dryers only).
007-1829-6	Pressure Gauge 400 Lbs. (Glycerin-Filled)	Used in gas train (LP dryers only).

Regulators and Parts

Part #	Description	Where Used
Rockwell		
GT3-0169	Regulator, Gas Equimeter 3" 12112-12	Main Gas Regulator - Size Specific
GT3-0012	Regulator, Gas Equimeter 2-1/2" 12112-10	Main Gas Regulator - Size Specific
GT3-0471	Regulator, Gas Equimeter 2" 12112-8	Main Gas Regulator - Size Specific
707-1587-5	Regulator Spring Black Rockwell	Standard spring for above regulators.
707-1560-2	Regulator Spring Gold Rockwell (Cadmium)	Heavier spring for above regulators.
Pilot Regulator (All GSI and Zimmerman)		
GT3-0033	Regulator Fisher 1/2" (Pilot)	Regulates gas to the pilot.

Gas Pressure Switches

Part #	Description	Where Used
KD-PES0049	Switch, Low Gas Pressure Honeywell #C6097A1053	Detects low gas pressure in gas train.
GT3-1762	Switch, High Gas Pressure Honeywell #C6097B3101	Detects high gas pressure in gas train.

7. Parts List

Maxon Shut Off Valves, Switches and Solenoids

Part #	Description	Where Used
Manual 808 Valves		
GT3-0624	Valve, Maxon 2" 808	Used in gas train (switches separate) - Size specific.
GT3-0206	Valve, Maxon 3" 808-CP	Used in gas train (switches separate) - Size specific.
GT3-0213	Valve, Maxon 4" F 808-CP	Used in gas train (switches separate) - Size specific.
GT3-1025	Valve, Maxon 6" 808 VLV	Used in gas train (switches separate) - Size specific.
Motorized Valves		
707-1582-6	Valve, Maxon 2" Motorized 5000 Series	Used in gas train (switches separate) - Size specific.
GT3-0823	Valve, Maxon 3" Motorized 5000 Series W/VCS-2 Switch	Used in gas train - Size specific.
707-1441-5	Valve, Maxon 4" Motorized 5000 Series	Used in gas train (switches separate) - Size specific.
GT3-1107	Valve, Maxon 6" Motorized 7000 Series	Used in gas train (switches separate) - Size specific.
Single Switch		
GT3-0620	Switch Set VCS-1 (SOV) Maxon VOS-1 #14-23433	Maxon switch 3" valve and up.
GT3-0623	Switch Set VCS-1 (VOS-1) Maxon #14-18428	Maxon switch 2" valve and below.
Double Switch		
GT3-0619	Switch Set VCS-2 (SOV) Maxon Vos-2 (STO) #14-23434	Double maxon switch 3" valve and up.
GT3-0622	Switch Set VCS-2 (VOS-2) Maxon #14-18429	Double maxon switch 2" valve and below.
KD-PVA0005	Solenoid Maxon Coil 22055	Solenoid 2" and 3" non-motorized maxon.
769-1028-0	Solenoid 23243	Solenoid 4" non-motorized maxon.

CV Valves and Components

Part #	Description	Where Used
GT3-0515	CV Valve 2"	Controls flow of gas to burner - Size specific.
GT3-0132	Valve, 3" CV Series	Controls flow of gas to burner - Size specific.
GT3-0214	Valve, Maxon 4" F CV	Controls flow of gas to burner - Size specific.
769-1024-9	Butterfly Shaft 4"	Replacement Part for 4" CV Valve
769-1197-3	O-Ring 2" Shaft	Replacement Part for 2" CV Valve
GT3-1593	Adaptor Bushing MR Valve Arm	Round to square bushing in 4" valve arm that connects arm to modutrol motor.

PLC and HMI Parts

Part #	Description	Function/Notes
GT3-1606	5-Port Ethernet Switch	Communication hub
GT3-1450	Filter, Line Active 120 VAC, 15A	Protects PLC from spikes and reduces noise to PLC.
GT3-1616	Compact Logix L16 PLC Processor	PLC - in operator box.
GT3-1607	Ethernet Adapter - Point I/O	Communicates with CompactLogix PLC in operator box.
GT3-1612	Module Base - Point I/O	Base for individual PLC cards.
GT3-1615	4-CH Universal Analog Input Module	Input card for moisture sensor connections.
GT3-1610	2-CH Analog Current Output Module	Output to drive VFD and modulating valve.
GT3-1614	2-CH RTD Input Module	Input card for plenum and grain temp sensors
GT3-1609	Blank Module	
GT3-1608	Power Bus Extension Module - Point I/O	
GT3-1613	4-PT Relay Output Module	
GT3-1611	8-PT DC Input Module	
GT3-1405	HMI Assembly, Panel View Plus 6	up to 2016
GT3-1680	HMI Assembly, Panel View 7 Performance	2016 and up

Inverters and Line Reactors

Part #	Description	Function/Notes
Inverters		
GT3-1730	Allen-Bradley Inverter, VFD AB PF523 2 HP/230V	Variable speed drive for unload - Size and voltage specific.
GT3-1729	Allen-Bradley Inverter, VFD AB PF523 2 HP/460V	Variable speed drive for unload - Size and voltage specific.
GT3-1732	Allen-Bradley Inverter, VFD AB PF523 2 HP/575V	Variable speed drive for unload - Size and voltage specific.
GT3-1728	Allen-Bradley Inverter, VFD AB PF523 5 HP/230V	Variable speed drive for unload - Size and voltage specific.
GT3-1727	Allen-Bradley Inverter, VFD AB PF523 5 HP/460V	Variable speed drive for unload - Size and voltage specific.
GT3-1735	Allen-Bradley Inverter, VFD AB PF523 5 HP/575V	Variable speed drive for unload - Size and voltage specific.
Line Reactors		
GT3-0975	Reactor, Line 2 HP 230V 7.5 Amp	Protects inverter from voltage spikes - Size and voltage specific.
GT3-0976	Reactor, Line 2 HP 460V-575V 3.4 Amp	Protects inverter from voltage spikes - Size and voltage specific.
GT3-0482	Reactor, Line 5 HP 230V 15.2 Amp	Protects inverter from voltage spikes - Size and voltage specific.
GT3-0129	Reactor, Line 5 HP 460V 7.6 Amp	Protects inverter from voltage spikes - Size and voltage specific.
GT3-1389	Reactor, Line 5 HP 575V	Protects inverter from voltage spikes - Size and voltage specific.

7. Parts List

Useful/Miscellaneous

Part #	Description	Where Used
TD-100077	Alarm 120 Weather Proof	Alarms when dryer shuts down for any reason.
756-1213-5	Air Switch Differential JD2-Blue	Mounted in power panel - Prove blower is running
GT3-1037	Start/Stop/Pilot Kit	Complete start/stop switch kit - Used to control legs, conveyors.
GT3-1227	Push Button, Green, AB 800F	Replacement green start button (button only).
GT3-1228	Push Button, Red, AB 800F	Replacement red stop button (button only).

Service Parts Kits

Part #	Description	Where Used
GT4-SRVSCH1	Service Parts Kit Standard Includes The Following Parts: 1 - Igniter (Natural Gas or LP) 1 - Flame Rod (Natural Gas or LP) 1 - ACF Relay 1 - Flame PAC 1 - SS3CP Transformer 1 - Adjustable Plenum Hi-Limit 2 - 36' Overheat (Fixed Hi-Limit)	This kit contains essential parts that cannot be bypassed and will prevent the dryer from running if they fail.
GT4-SRVSCH2	Service Parts Kit Expanded Includes The Following Parts: 1 - Complete Kit 1 (GT4-SRVSCH1) 1 - Honeywell Modutrol Motor M7284A 1012 1 - Ounce Gauge 1 - Sensor, Platinum RTD Honeywell 1 - Air Switch 6 - Burner Drill Bits	This kit contains all parts in kit 1 plus some additional parts that should be kept on hand.

Commercial Tower Dryer Sidewall Sheets - GSI and ZIMMERMAN Inside Galvanized Sheets

Inside 12' Diameter Dryer

Part #	Description	Where Used
GT1-0405	Sheet, Wall Inside Top 12'	Top Ring
GT1-0406	Sheet, Wall Inside Heat 12'	Heat Section
GT1-0407	Sheet, Wall Inside Cleanout 12'	Inside at Grain Inveter
GT1-0408	Sheet, Wall Inside Cool 12'	Cooling Section
GT1-0409	Sheet, Wall Inside Bottom 12'	Bottom Ring

Inside 18' Diameter Dryer

Part #	Description	Where Used
GT1-0195	Sheet, Wall Inside Top 18'	Top Ring
GT1-0193	Sheet, Wall Inside Heat 18'	Heat Section
GT1-0229	Sheet, Wall Inside Cleanout 18'	Inside at Grain Inveter
GT1-0194	Sheet, Wall Inside Cool 18'	Cooling Section
GT1-0177	Sheet, Wall Inside Bottom 18'	Bottom Ring

Inside 24' Diameter Dryer

Part #	Description	Where Used
GT1-0381	Sheet, Wall Inside Top 24'	Top Ring
GT1-0289	Sheet, Wall Inside Heat 24'	Heat Section
GT1-0383	Sheet, Wall Inside Cool 24'	Cooling Section
GT1-0384	Sheet, Wall Inside Bottom 24'	Bottom Ring

Inside 30' Diameter Dryer

Part #	Description	Where Used
GT1-0706	Sheet, Wall Inside Top 30'	Top Ring
GT1-0707	Sheet, Wall Inside Heat 30'	Heat Section
GT1-0710	Sheet, Wall Inside Bottom 30'	Bottom Ring

Rolled Channel for Above Sheets

Part #	Description	Where Used
GT1-0505	Rolled Plenum Channel -12'	Horizontal channel that stiffeners inside sheets.
GT1-0008	Rolled Plenum Channel -18'	Horizontal channel that stiffeners inside sheets.
GT1-0447	Rolled Plenum Channel - 24'	Horizontal channel that stiffeners inside sheets.
GT1-0779	Rolled Plenum Channel - 30'	Horizontal channel that stiffeners inside sheets.
GT1-0011	Splice, Plenum Rolled Channel	Splice clip for all rolled channel

7. Parts List

Commercial Tower Dryer Corrugated Sidewall Sheets - GSI Only - Outside Stainless Sheets

Outside 12' Diameter Dryer

Part #	Description	Where Used
GT1-0590-12	Sheet, Wall Punched Blank Solid	Top rings, ring below grain inverter, ring above bottom ring.
GT1-0591-12	Sheet, Wall Punched Blank 0.078"	Above grain inverter and in cooling section.
GT1-0592-12	Sheet, Wall Punched Blank 0.063"	Below grain inverter but above cooling section.
GT1-0593-12	Sheet, Wall Punched Blank Bottom	Bottom Ring
GT1-1177-12	Sheet, Wall with Dual Cleanouts	Grain Inverter

Outside 18' Diameter Dryer

Part #	Description	Where Used
GT1-0590-18	Sheet, Wall Punched Blank Solid	Top rings, ring below grain inverter, ring above bottom ring.
GT1-0591-18	Sheet, Wall Punched Blank 0.078"	Above grain inverter and in cooling section.
GT1-0592-18	Sheet, Wall Punched Blank 0.063"	Below grain inverter but above cooling section.
GT1-0593-18	Sheet, Wall Punched Blank Bottom	Bottom Ring
GT1-1177-18	Sheet, Wall with Dual Cleanouts	Grain Inverter

Outside 24' Diameter Dryer

Part #	Description	Where Used
GT1-0590-24	Sheet, Wall Punched Blank Solid	Top rings, ring below grain inverter, ring above bottom ring.
GT1-0591-24	Sheet, Wall Punched Blank 0.078"	Above grain inverter and in cooling section.
GT1-0592-24	Sheet, Wall Punched Blank 0.063"	Below grain inverter but above cooling section.
GT1-0593-24	Sheet, Wall Punched Blank Bottom	Bottom Ring
GT1-1177-24	Sheet, Wall with Dual Cleanouts	Grain Inverter

Outside 30' Diameter Dryer

Part #	Description	Where Used
GT1-0590-30	Sheet, Wall Punched Blank Solid	Top rings, ring below grain inverter, ring above bottom ring.
GT1-0591-30	Sheet, Wall Punched Blank 0.078"	Above grain inverter and in cooling section.
GT1-0592-30	Sheet, Wall Punched Blank 0.063"	Below grain inverter but above cooling section.
GT1-0593-30	Sheet, Wall Punched Blank Bottom	Bottom Ring
GT1-1177-30	Sheet, Wall with Dual Cleanouts	Grain Inverter

Slide Gates for above and below Sheets

Part #	Description	Where Used
GT1-0074	Port, Discharge	Slide gate frames at bottom ring and at grain inverters.
GT1-0075	Plate, Discharge	Gates for slide gate frames.

Commercial Tower Dryer Sidewall Sheets - ZIMMERMAN Only - Outside Stainless Sheets

Outside 12', 18', 24' and 30' Diameter Dryer

Part #	Description	Where Used
GT1-0590	Sheet, Wall Punched Blank Solid	Top rings, ring below grain inverter, ring above bottom ring.
GT1-0591	Sheet, Wall Punched Blank 0.078"	Above grain inverter and in cooling section.
GT1-0592	Sheet, Wall Punched Blank 0.063"	Below grain inverter but above cooling section.
GT1-0593	Sheet, Wall Punched Blank Bottom	Bottom Ring
GT1-1177	Sheet, Wall with Dual Cleanouts	Grain Inverter

NOTES



Tower Dryer Domestic 3-Fan Wiring Diagrams

8. Tower Dryer - Domestic Wiring Diagrams

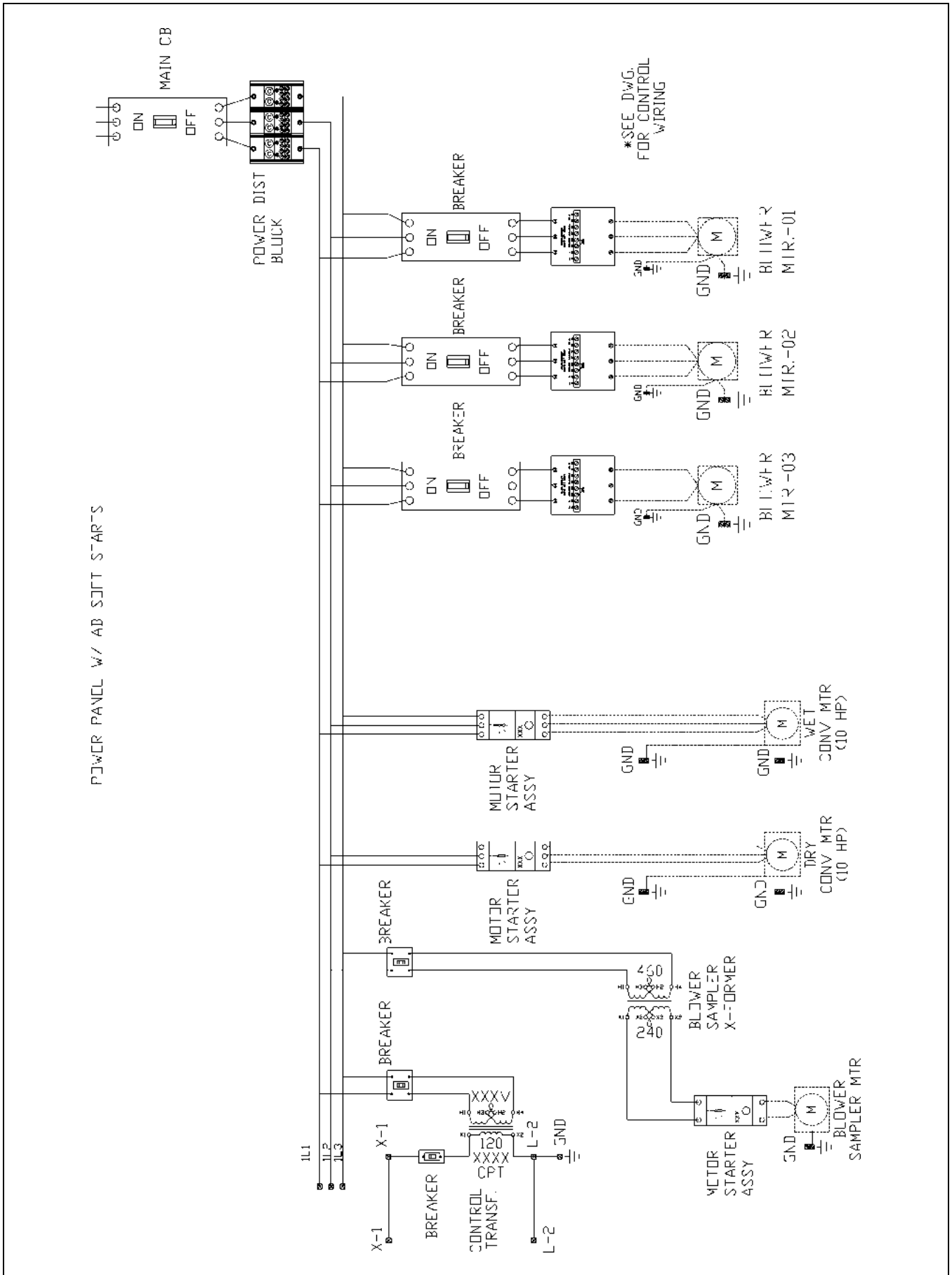

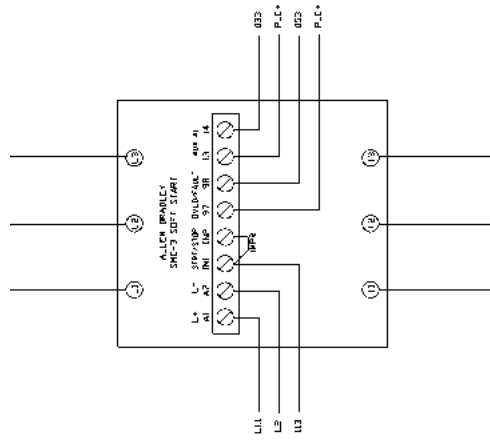

BLOWER #1

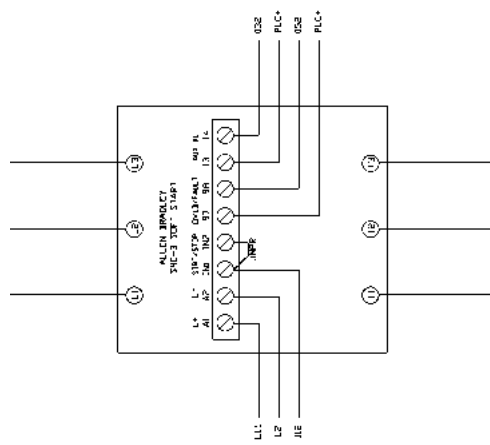

BLOWER #2

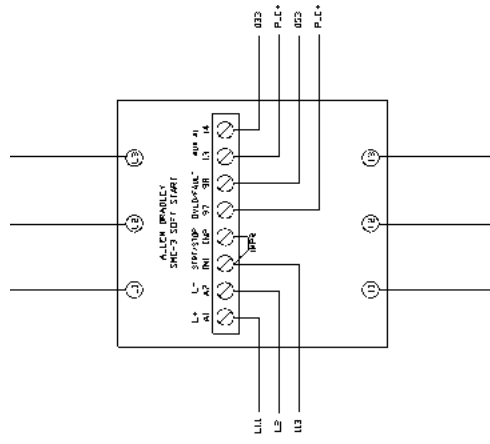

BLOWER #3

- 120VAC
- NEUTRAL
- EXTERNAL 24 VDC PS
- STARTER ACK TO PLC
- STARTER FAULT TO PLC
- P.C BLOWER #1 START RELAY
- P.C BLOWER #1 START RELAY

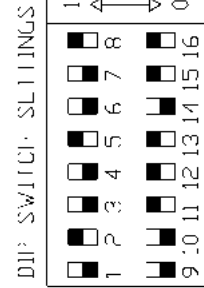

8. Tower Dryer - Domestic Wiring Diagrams

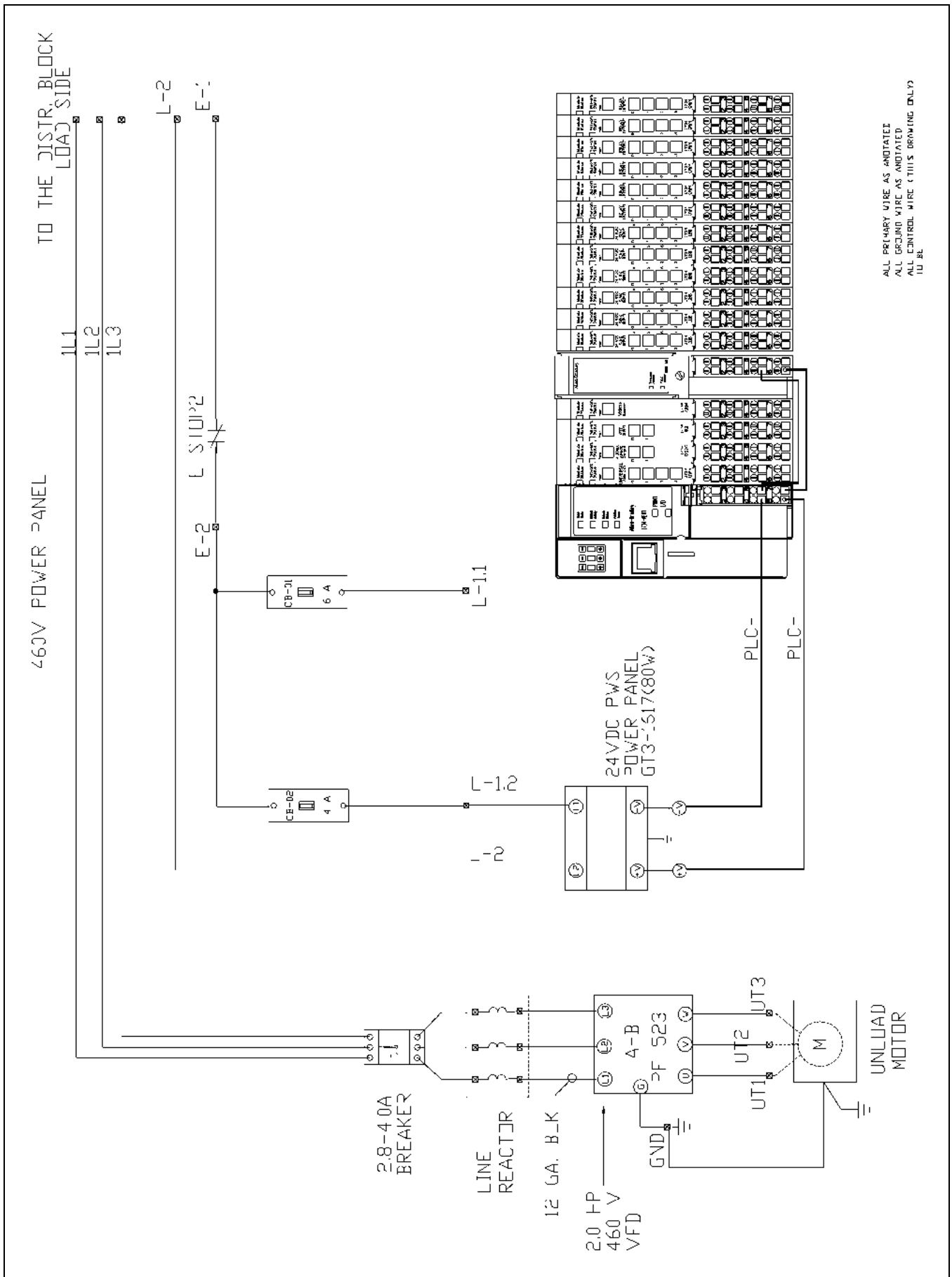

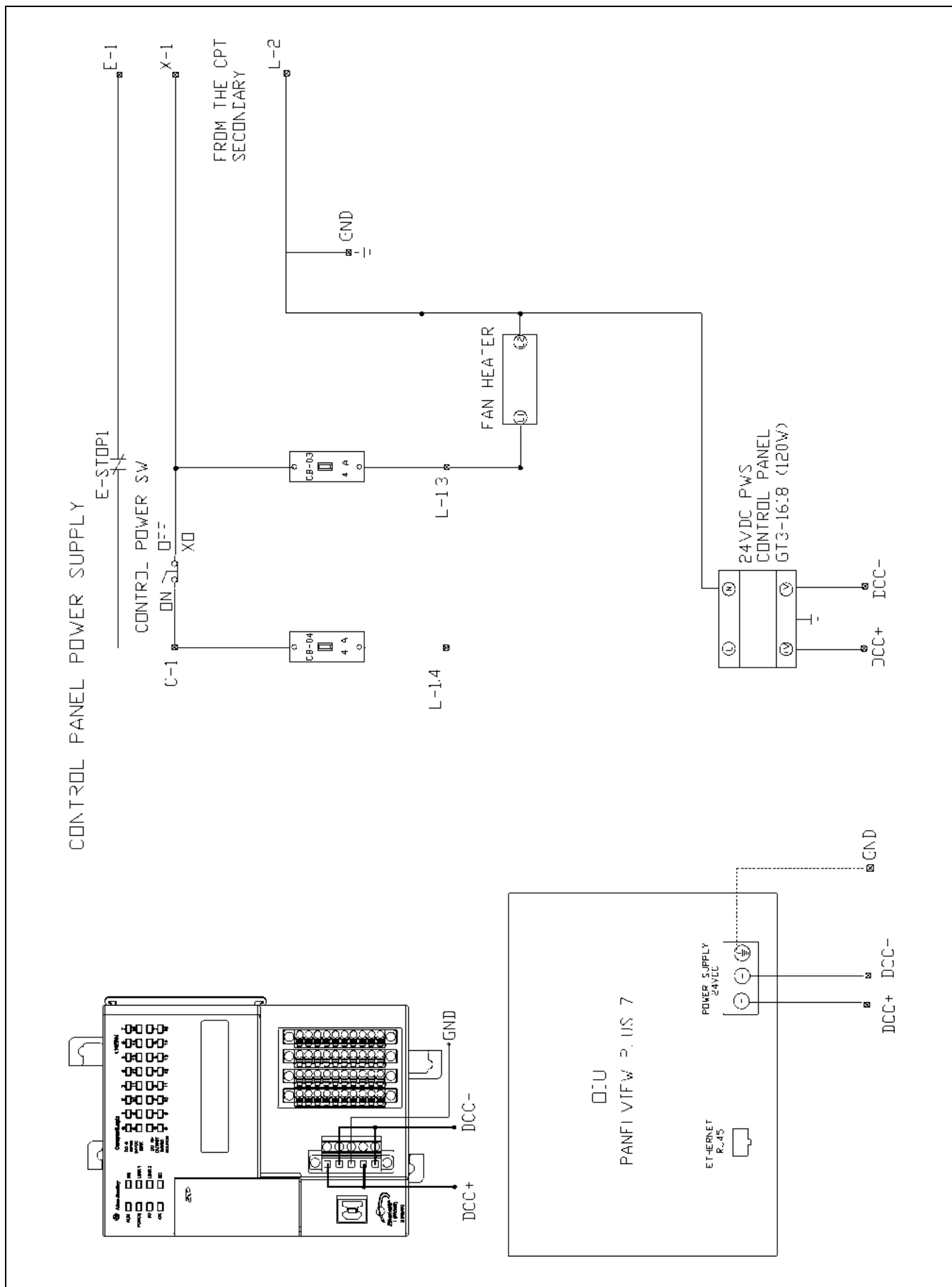

8. Tower Dryer - Domestic Wiring Diagrams

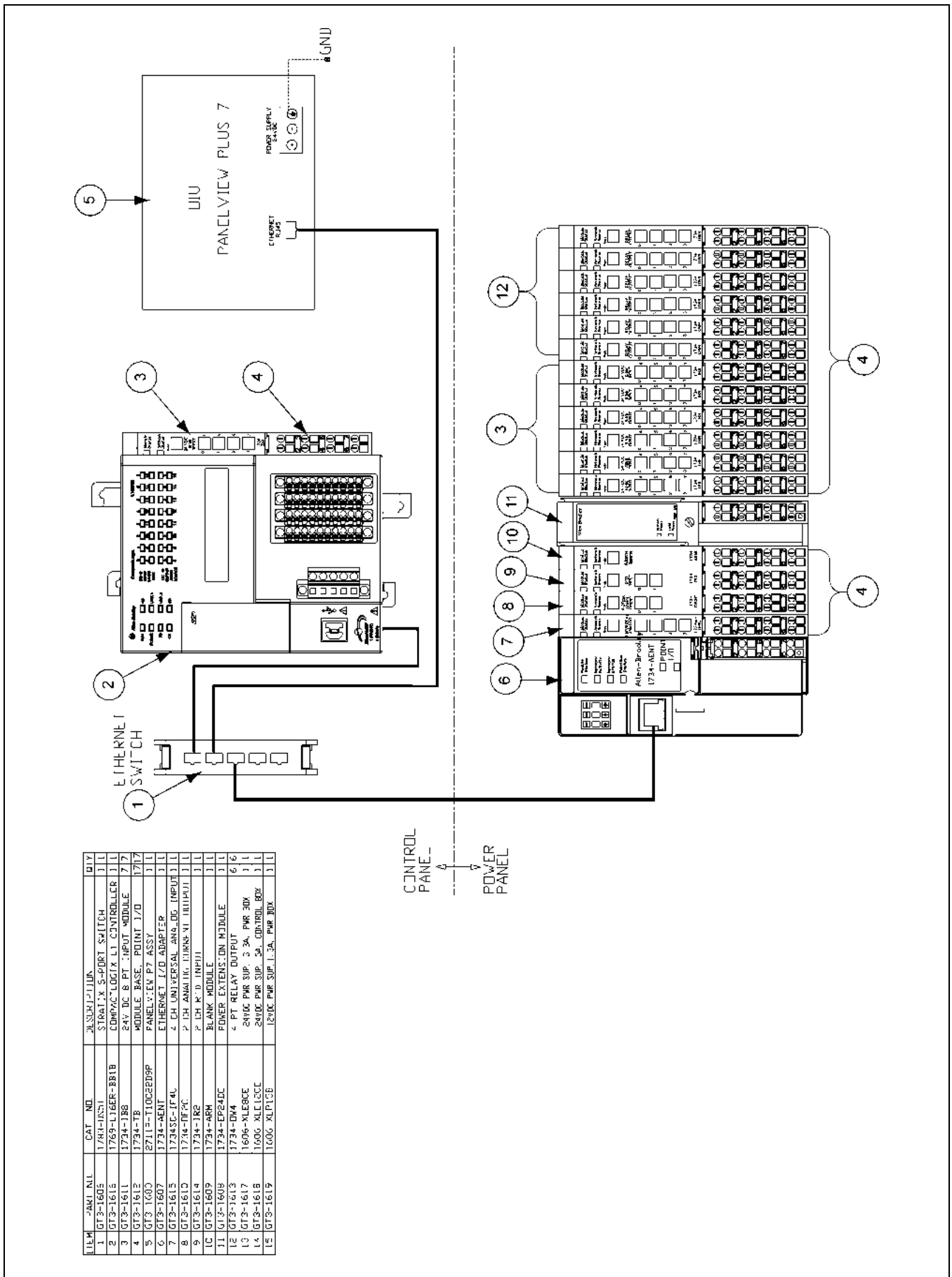

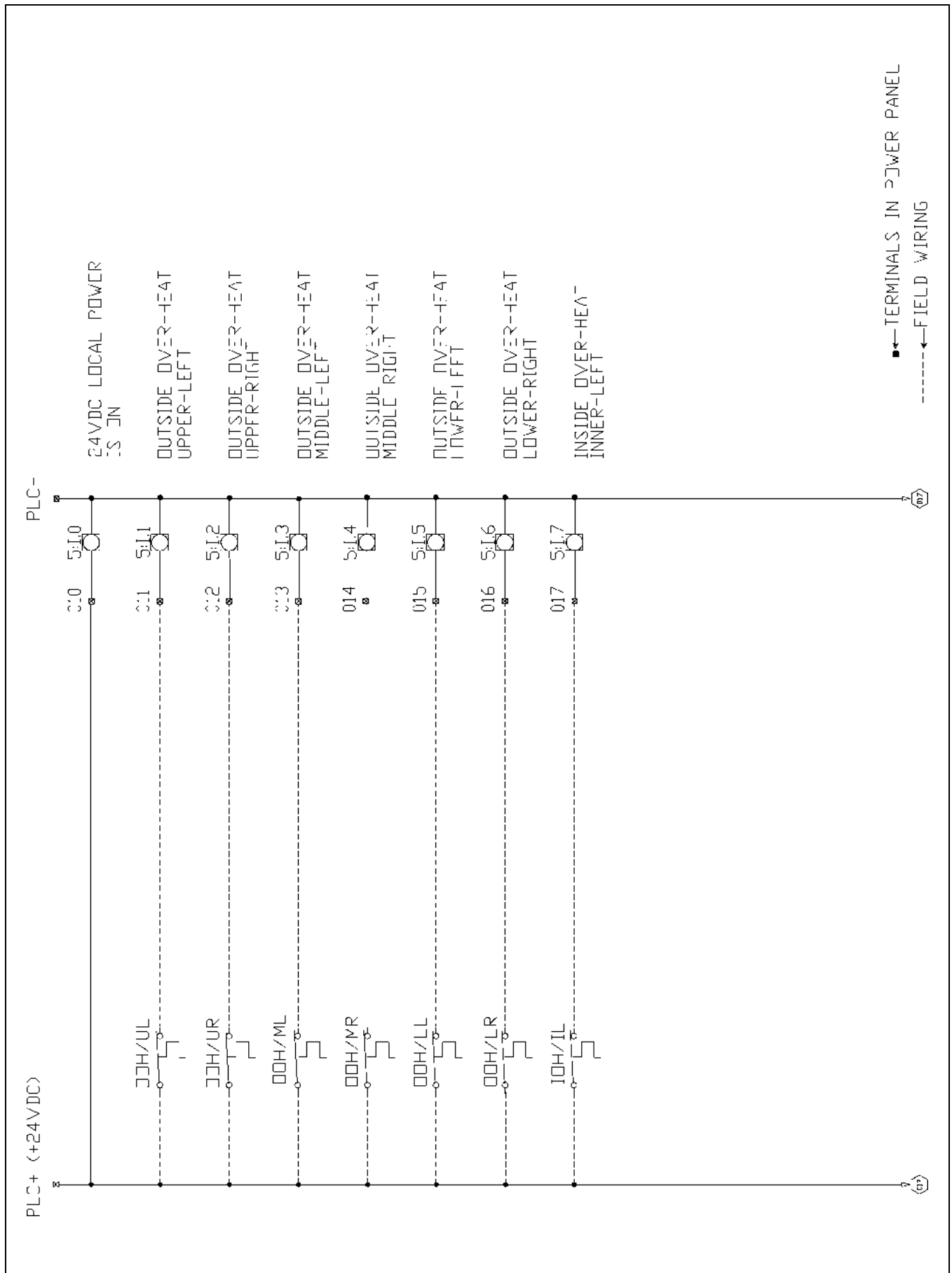

8. Tower Dryer - Domestic Wiring Diagrams

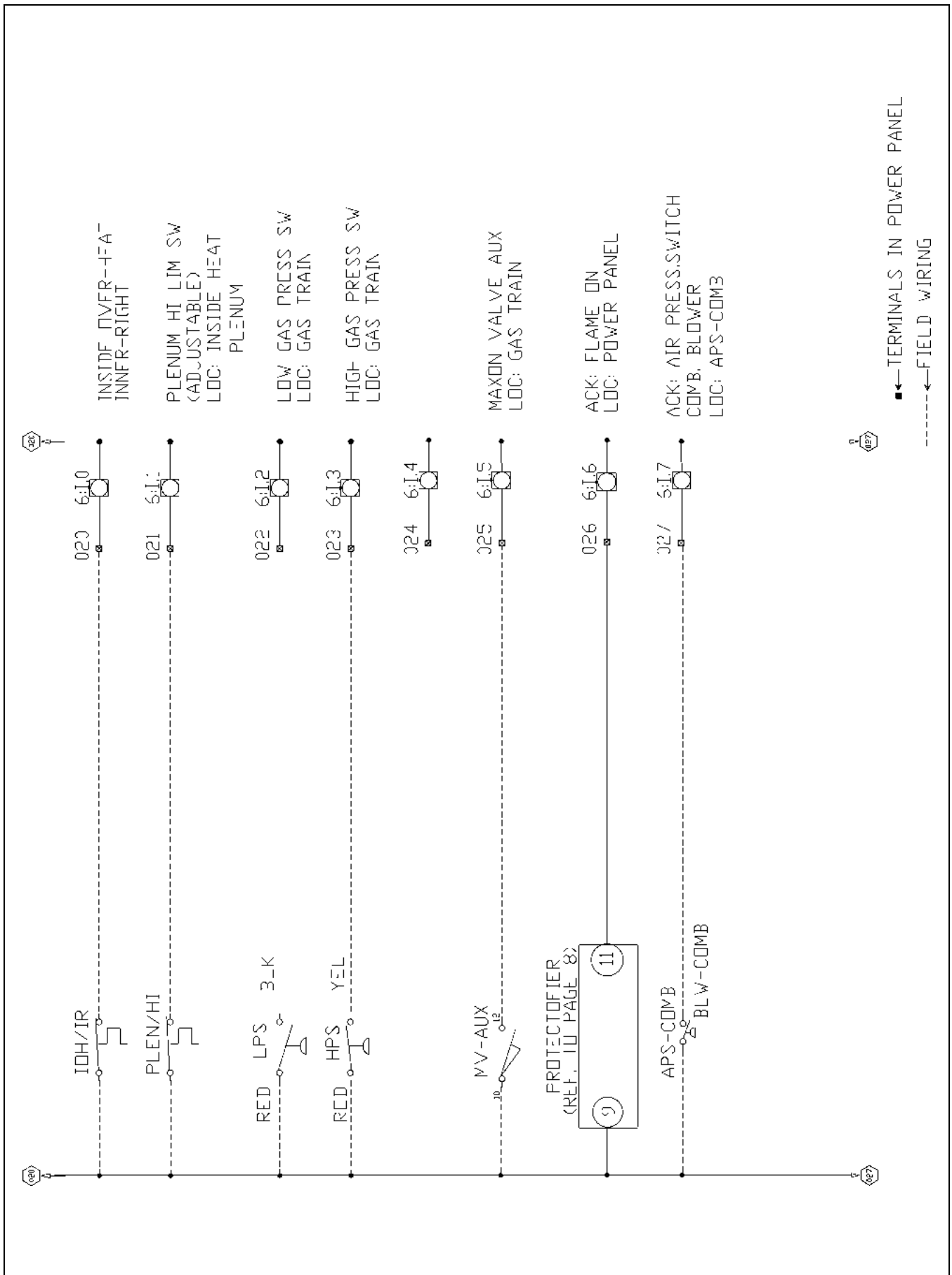

8. Tower Dryer - Domestic Wiring Diagrams

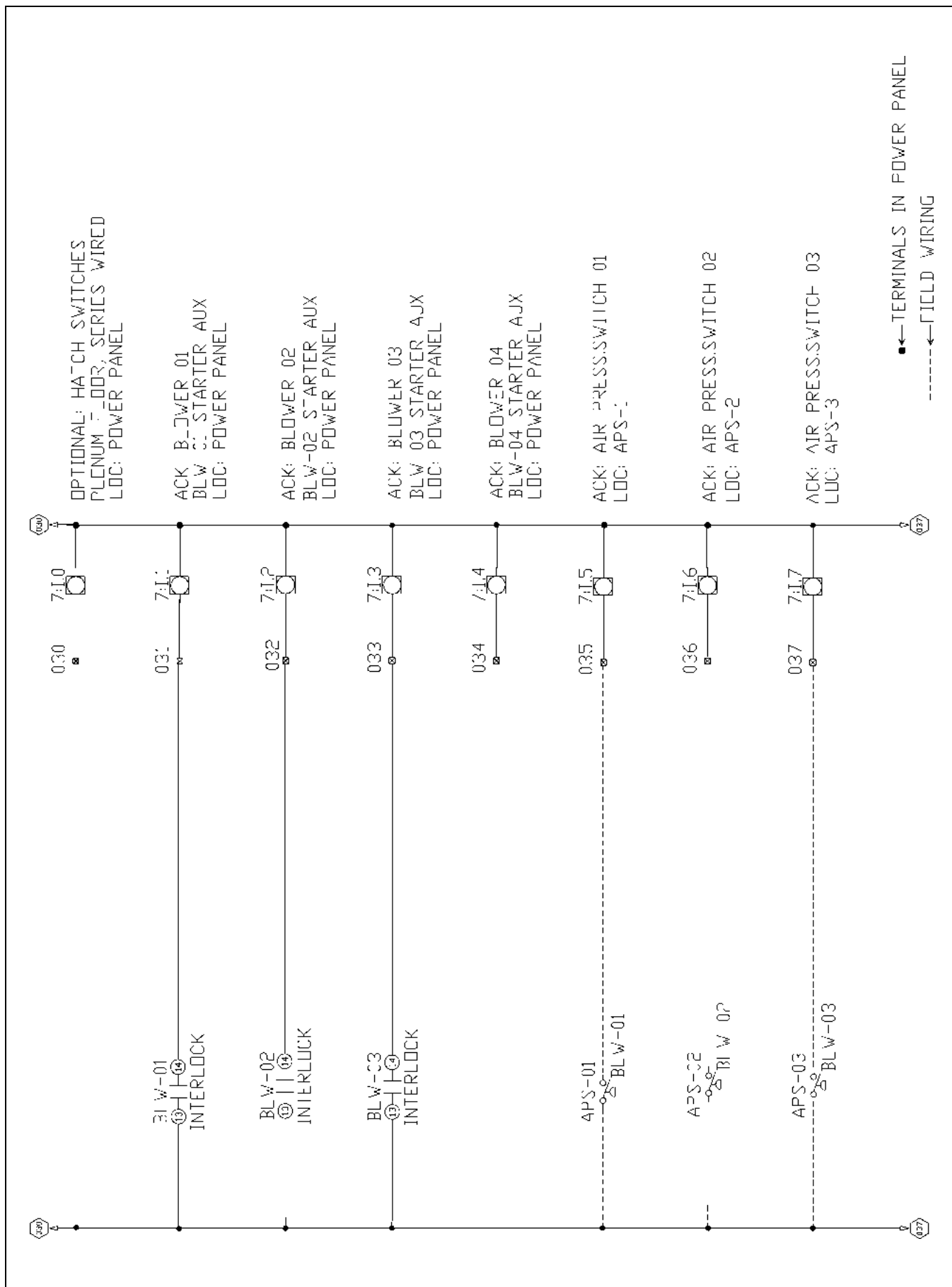

8. Tower Dryer - Domestic Wiring Diagrams

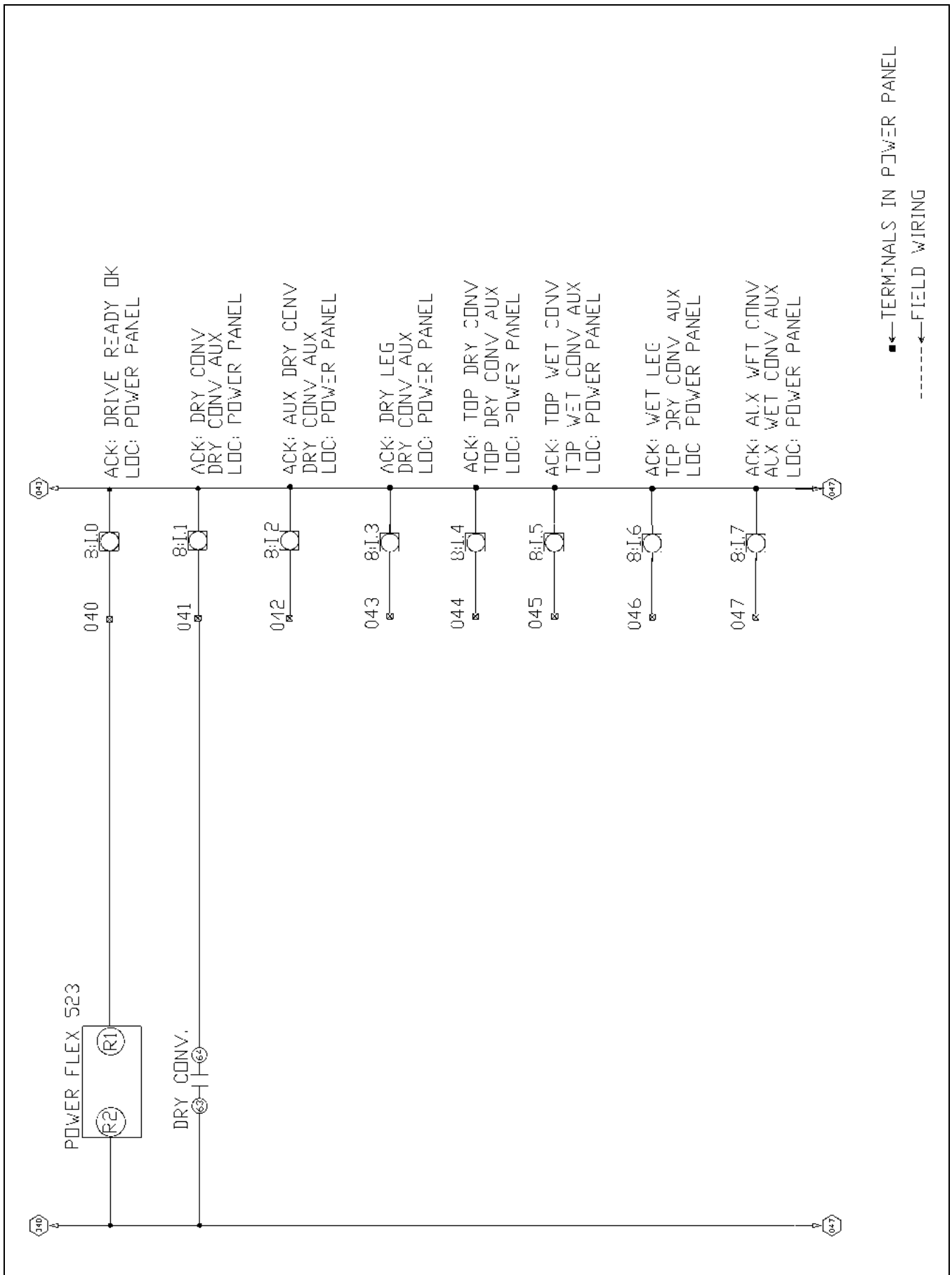

8. Tower Dryer - Domestic Wiring Diagrams

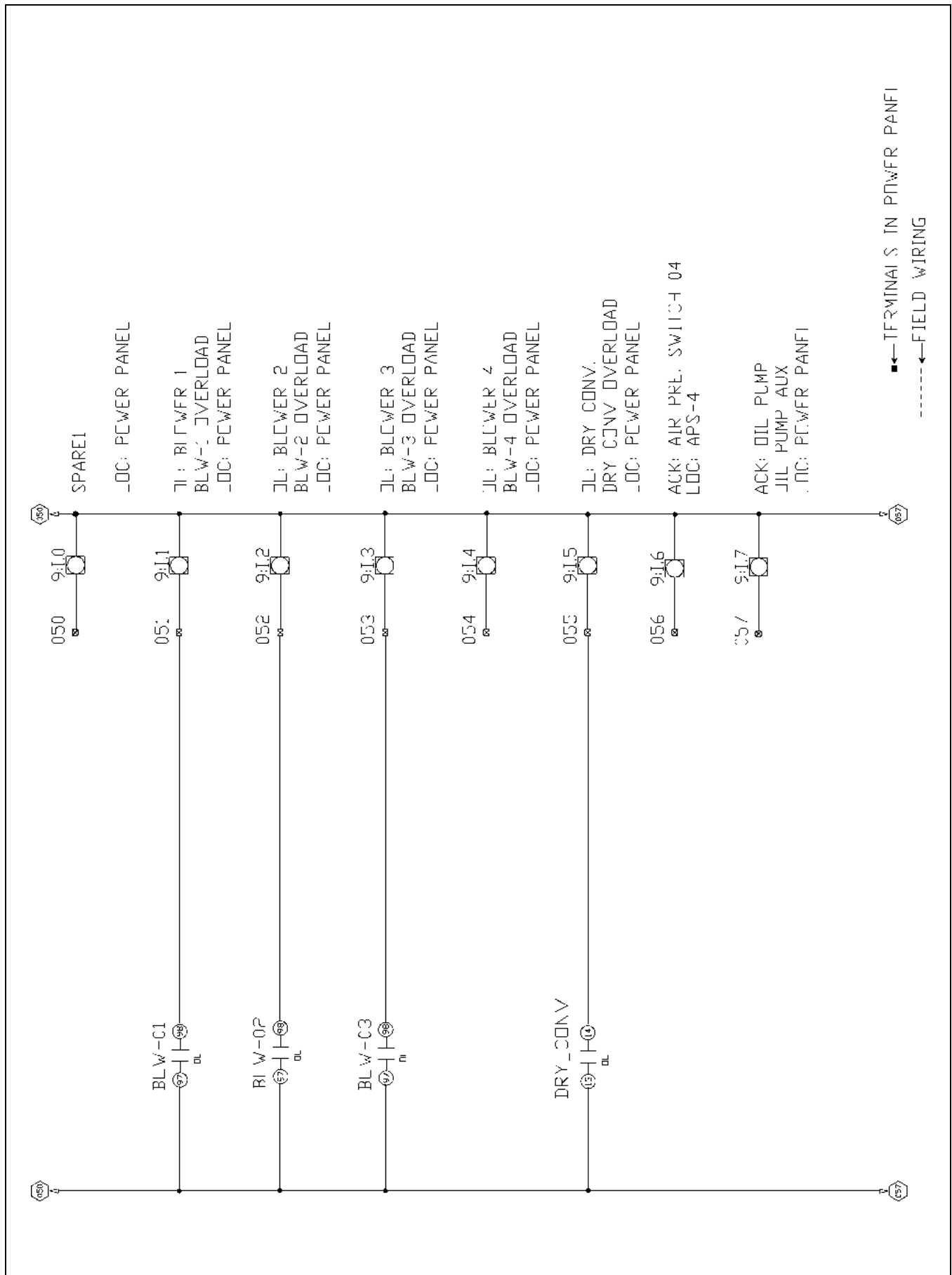

8. Tower Dryer - Domestic Wiring Diagrams

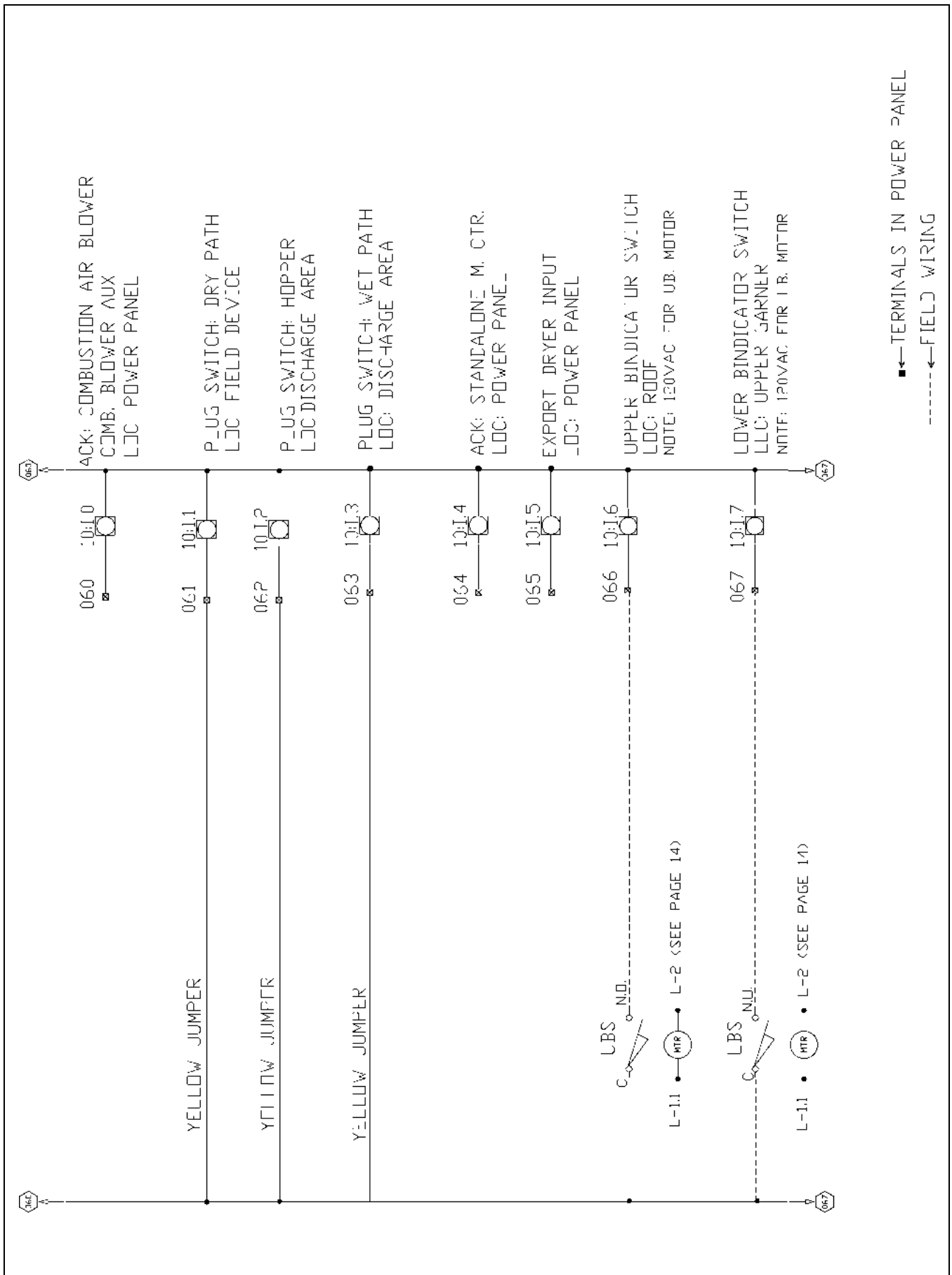

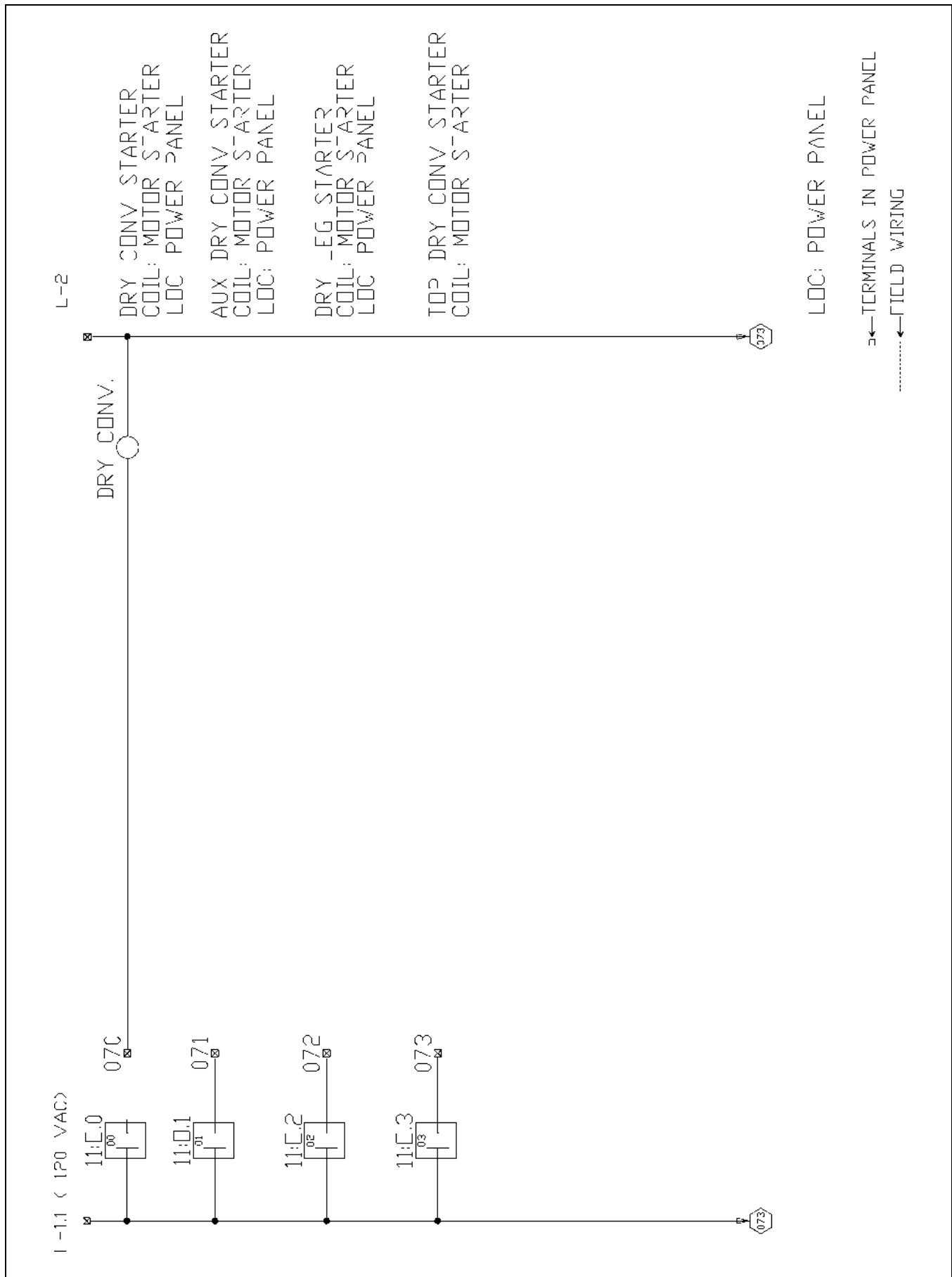

8. Tower Dryer - Domestic Wiring Diagrams

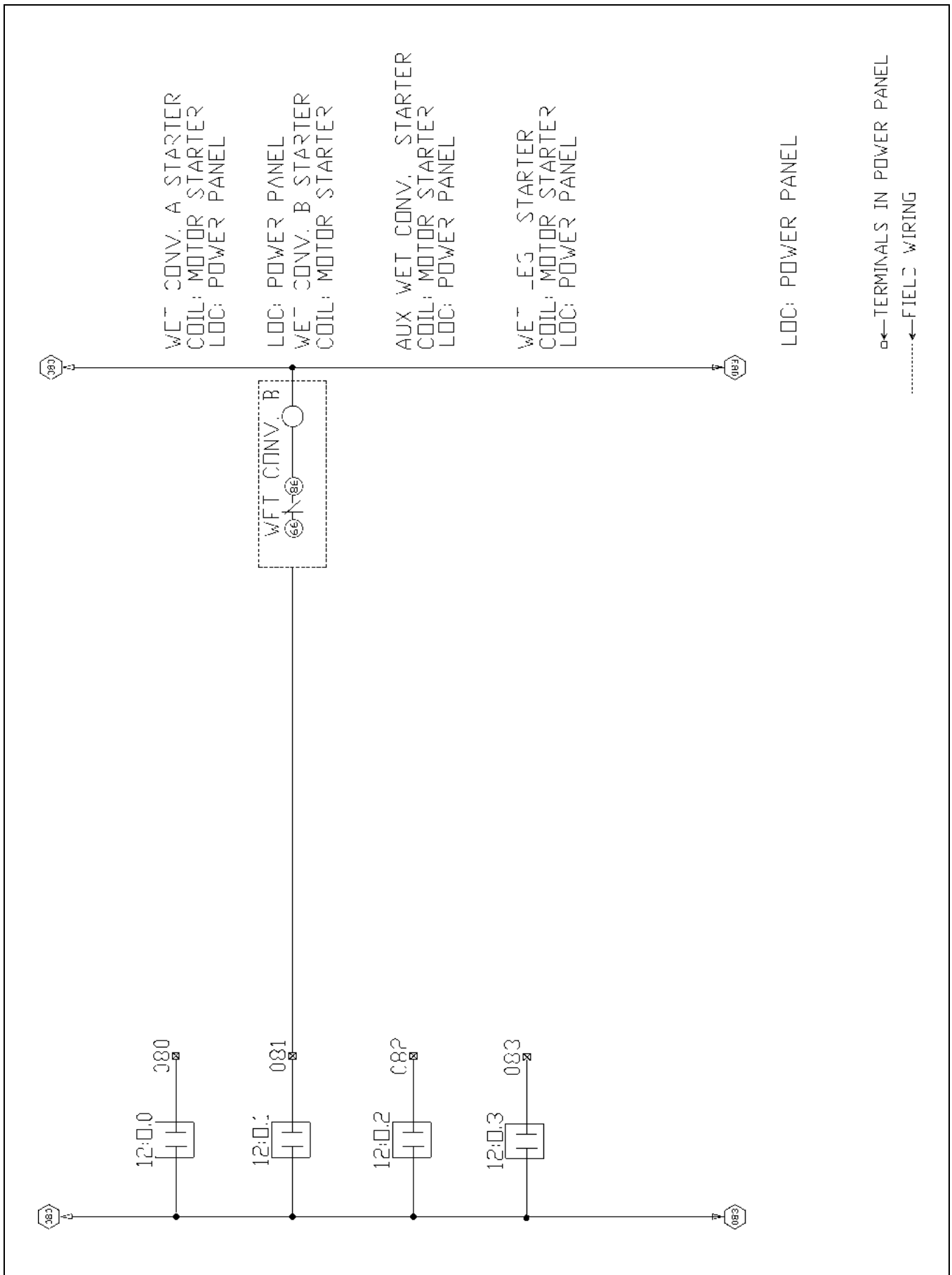

8. Tower Dryer - Domestic Wiring Diagrams

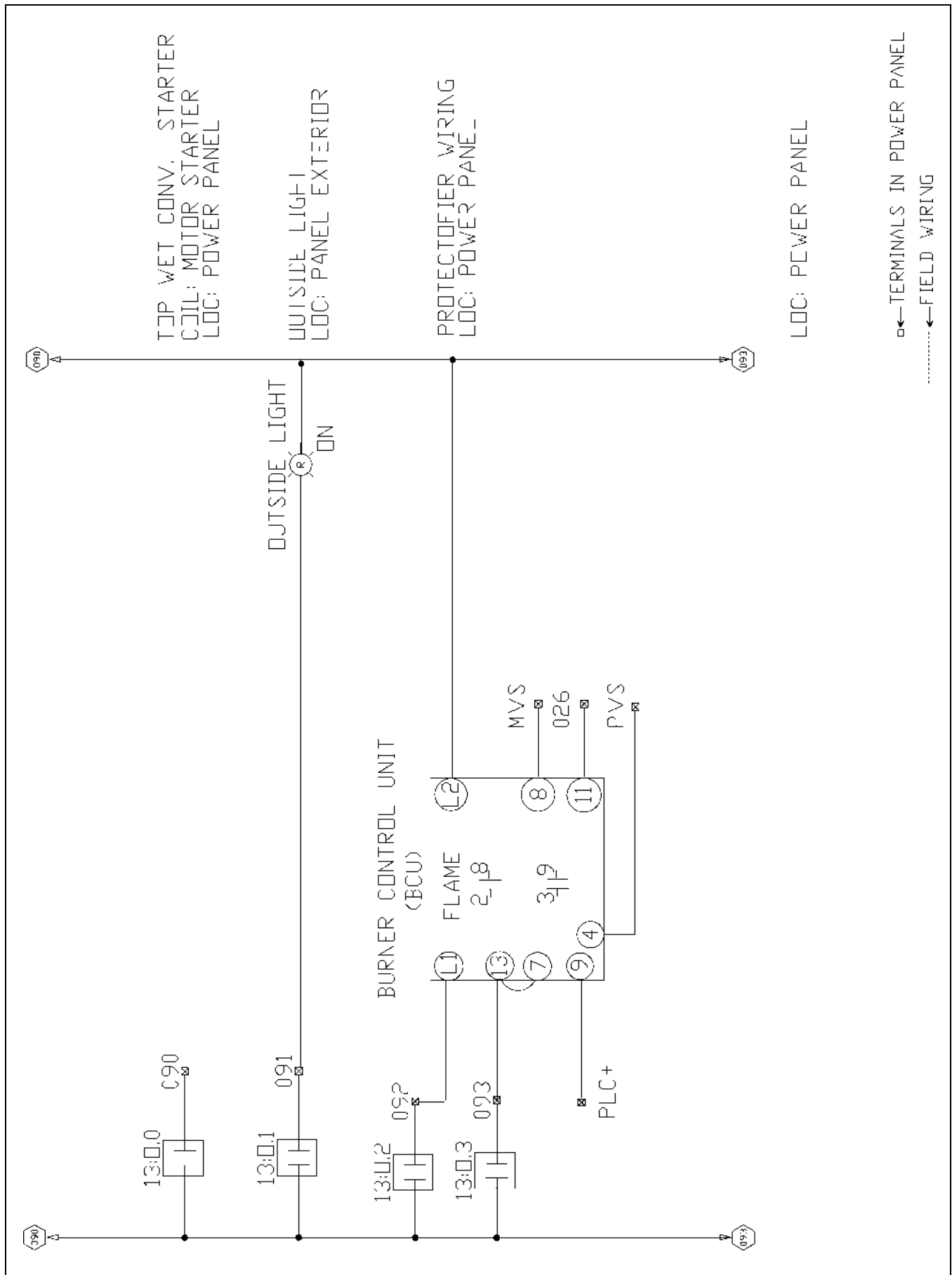

8. Tower Dryer - Domestic Wiring Diagrams

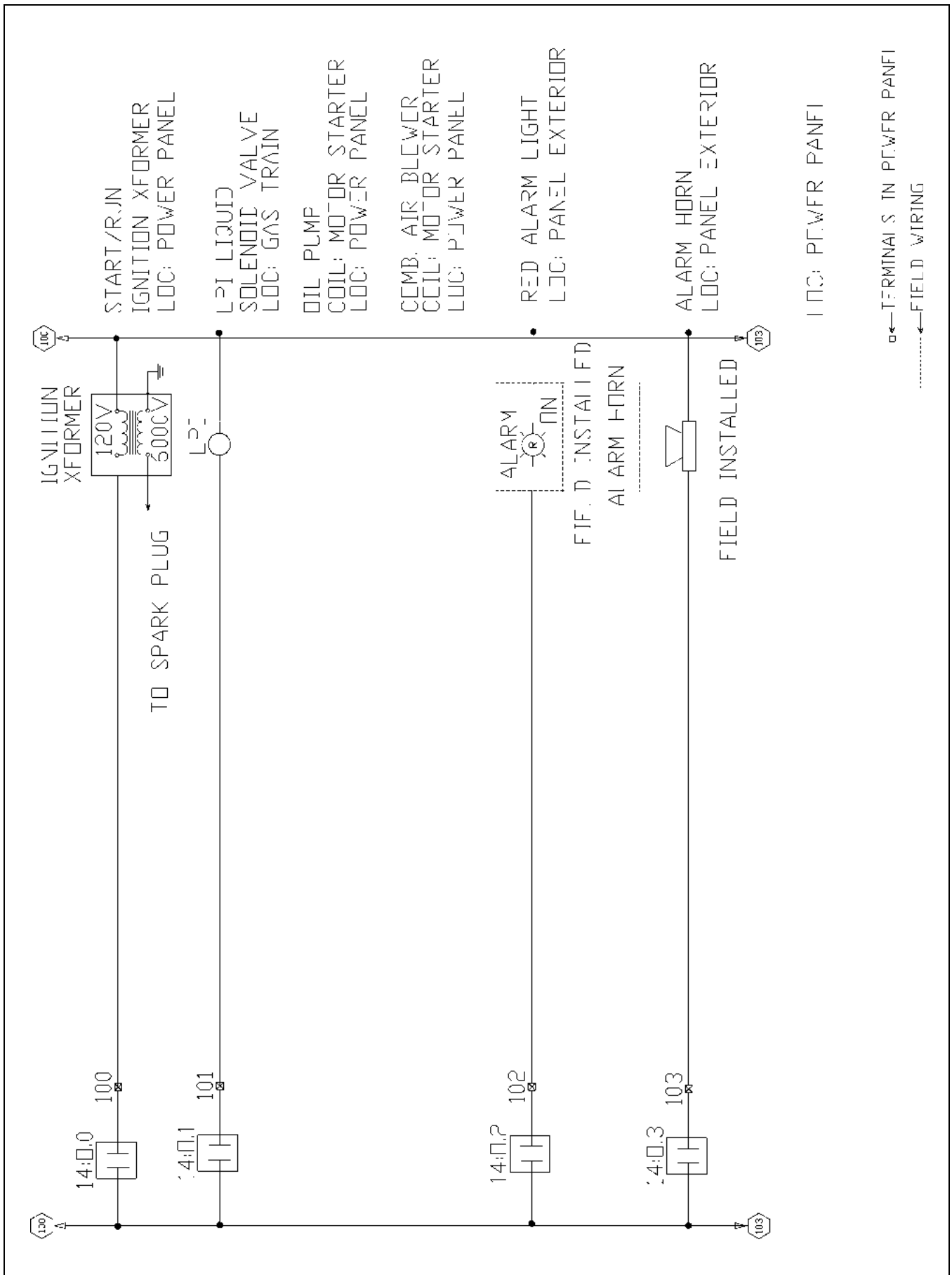

8. Tower Dryer - Domestic Wiring Diagrams

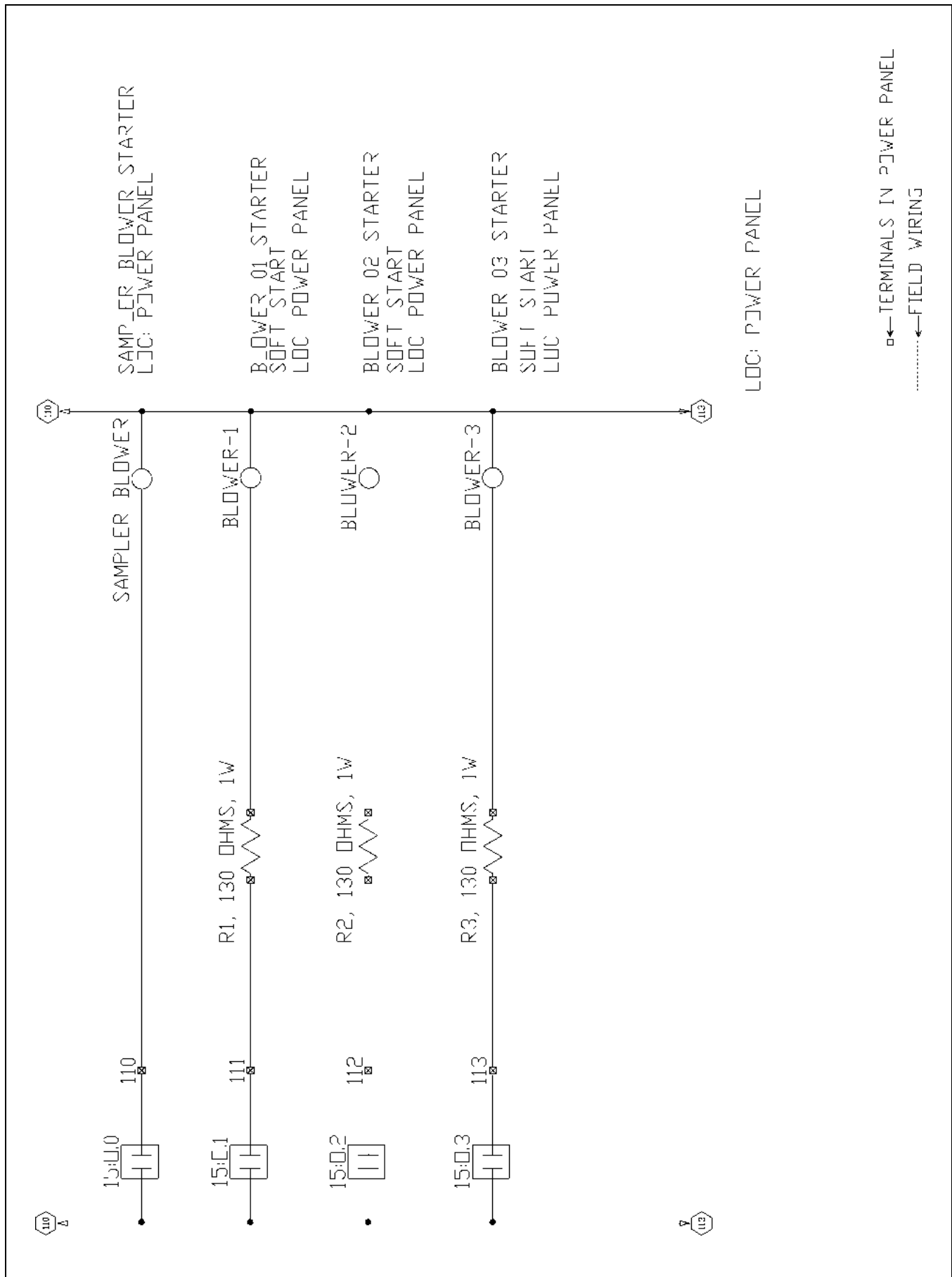

8. Tower Dryer - Domestic Wiring Diagrams

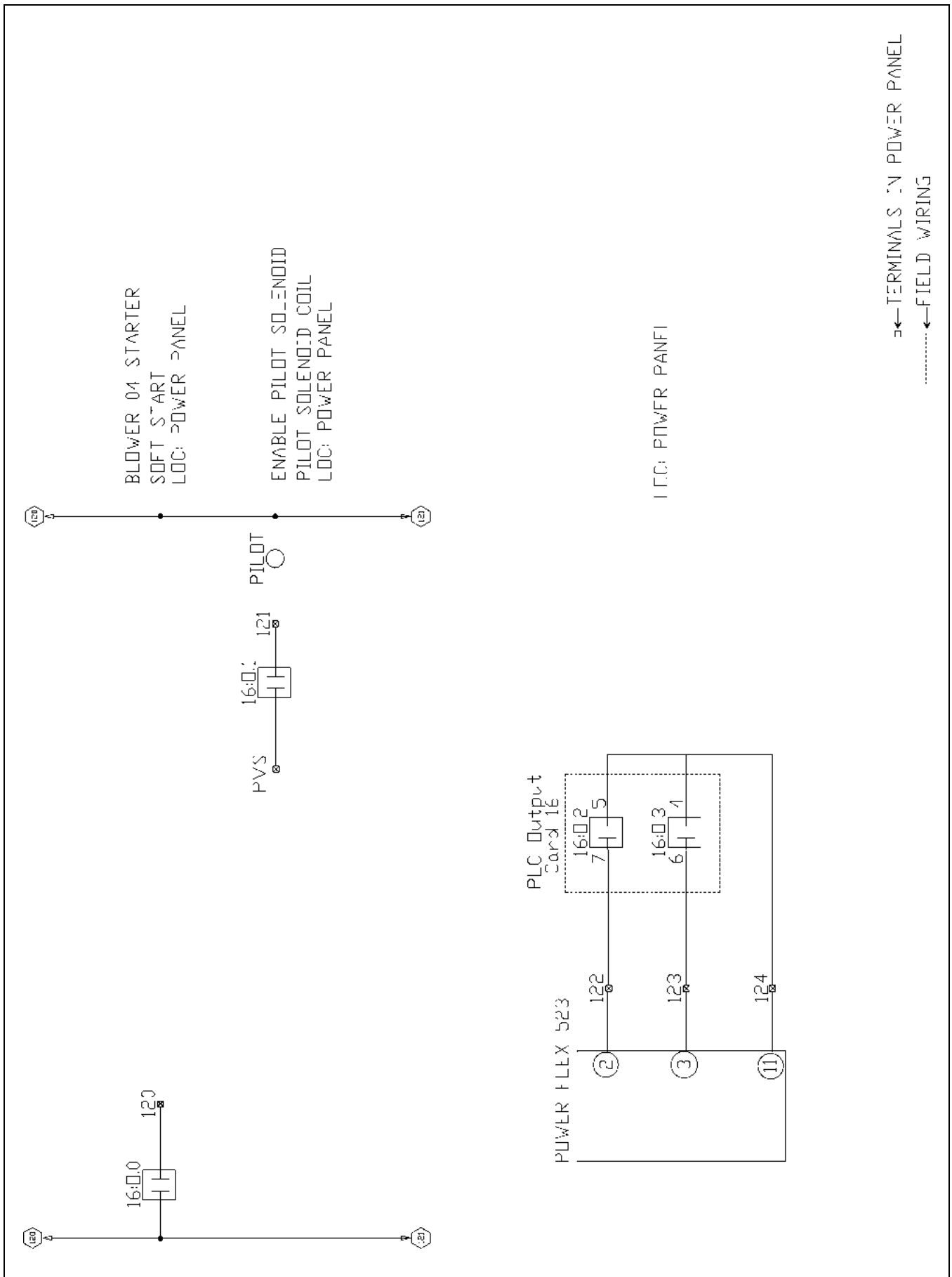

8. Tower Dryer - Domestic Wiring Diagrams

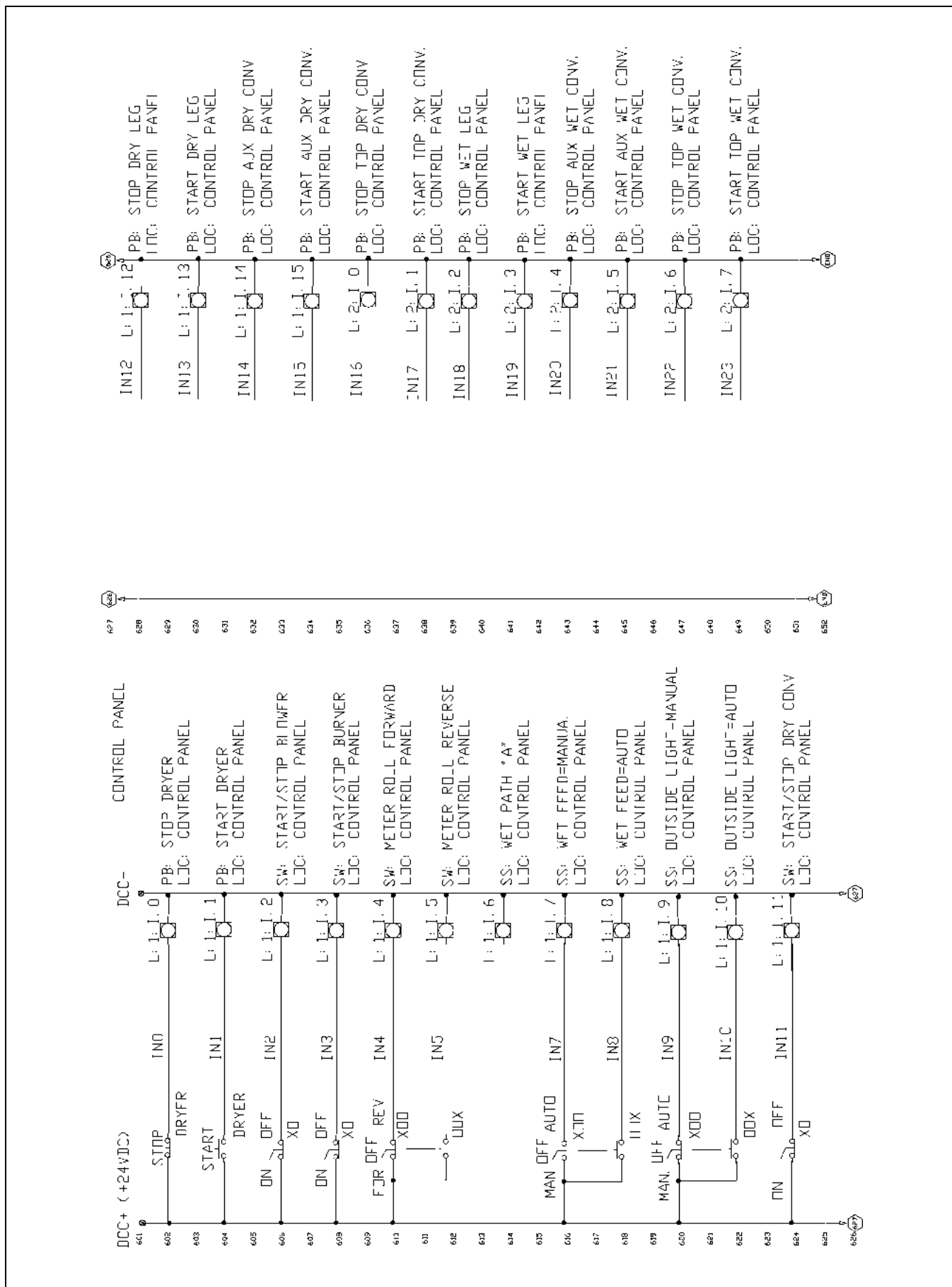

8. Tower Dryer - Domestic Wiring Diagrams

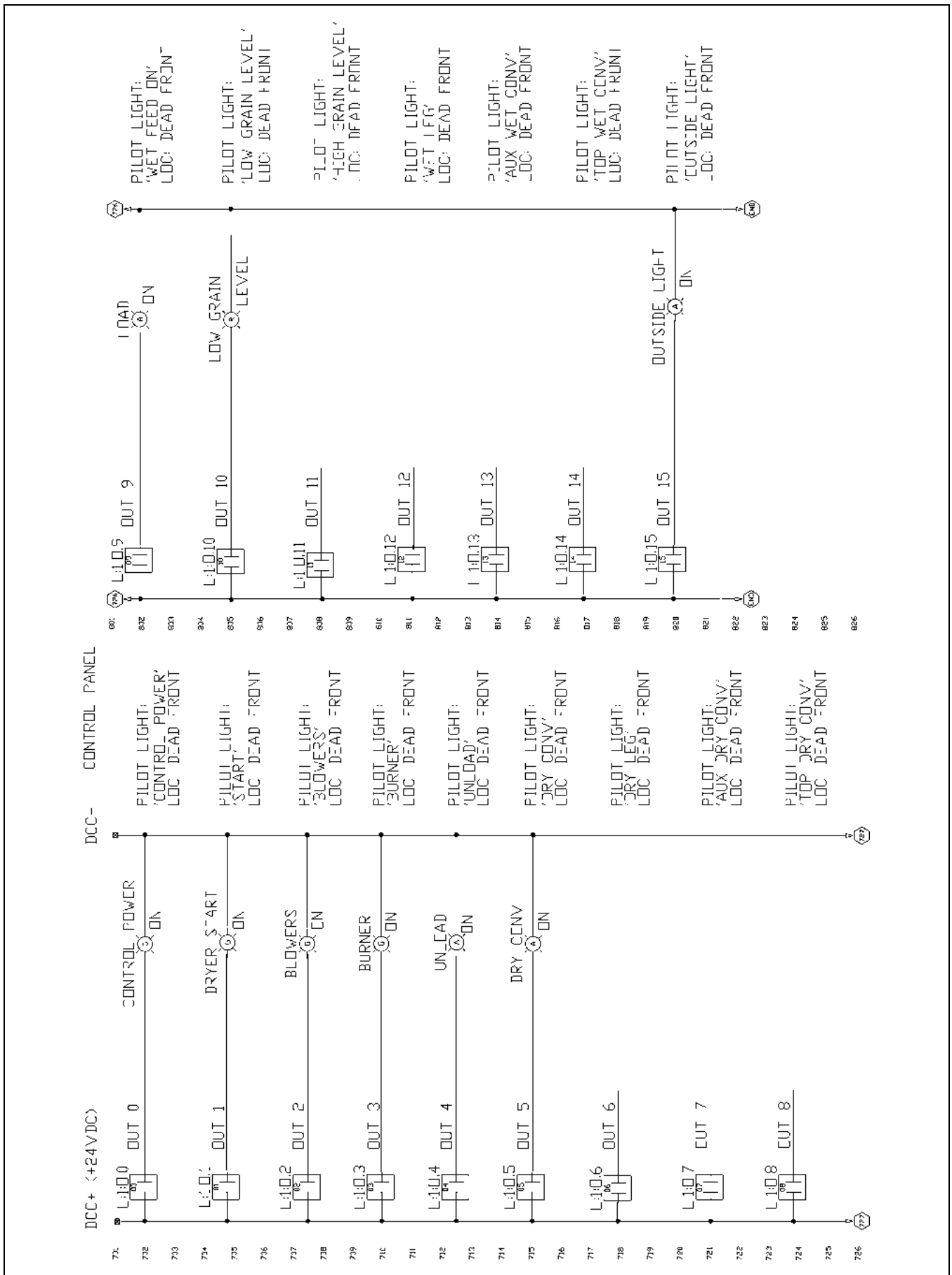

8. Tower Dryer - Domestic Wiring Diagrams

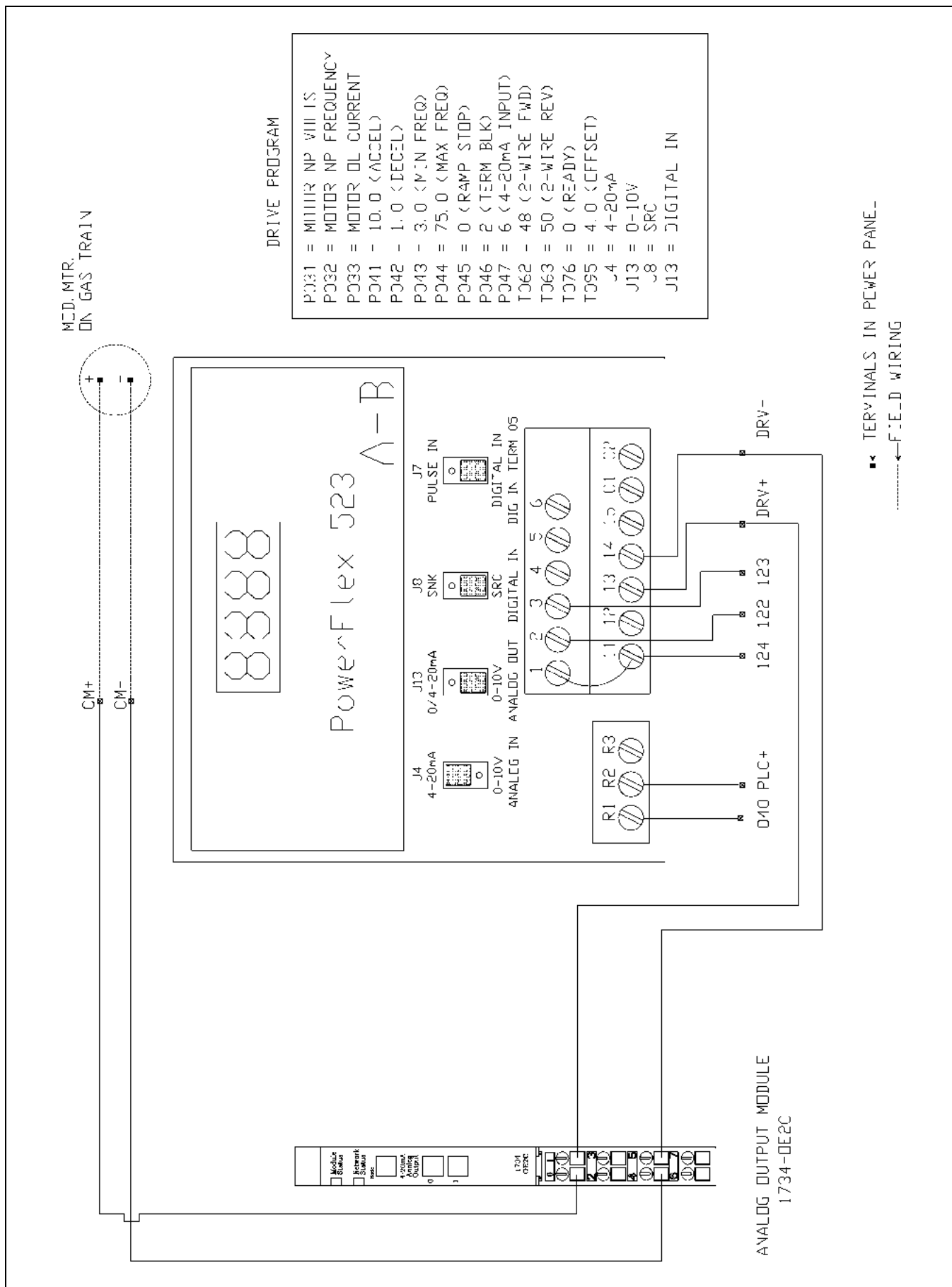

8. Tower Dryer - Domestic Wiring Diagrams

* MOUNT THE WCT SENSOR ON THE SIDE WALL OF THE CORNER BIN, 1' BELOW THE LOWER INDICATOR

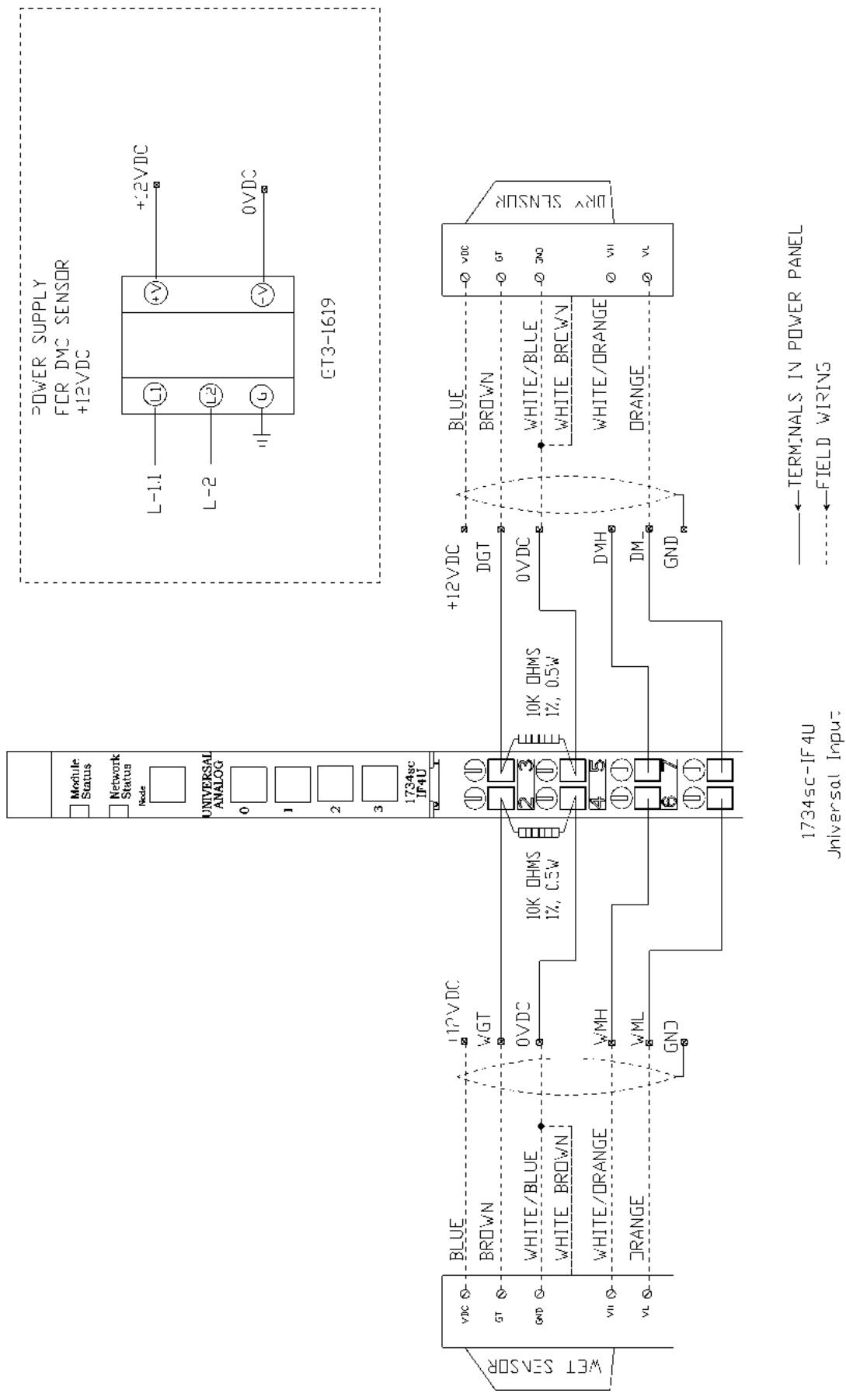

8. Tower Dryer - Domestic Wiring Diagrams

** MOUNT THE GRAIN RTD 3FT ABOVE THE END OF THE DRYING SECTION

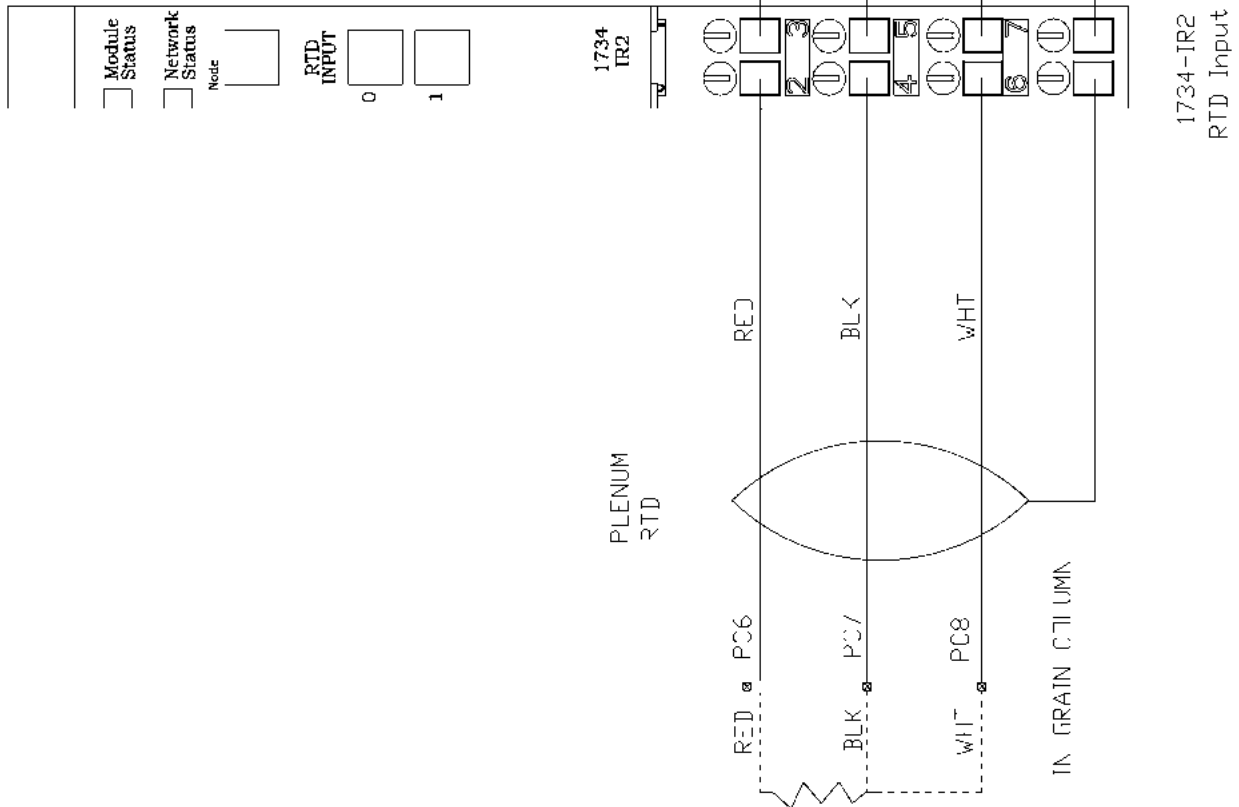

8. Tower Dryer - Domestic Wiring Diagrams

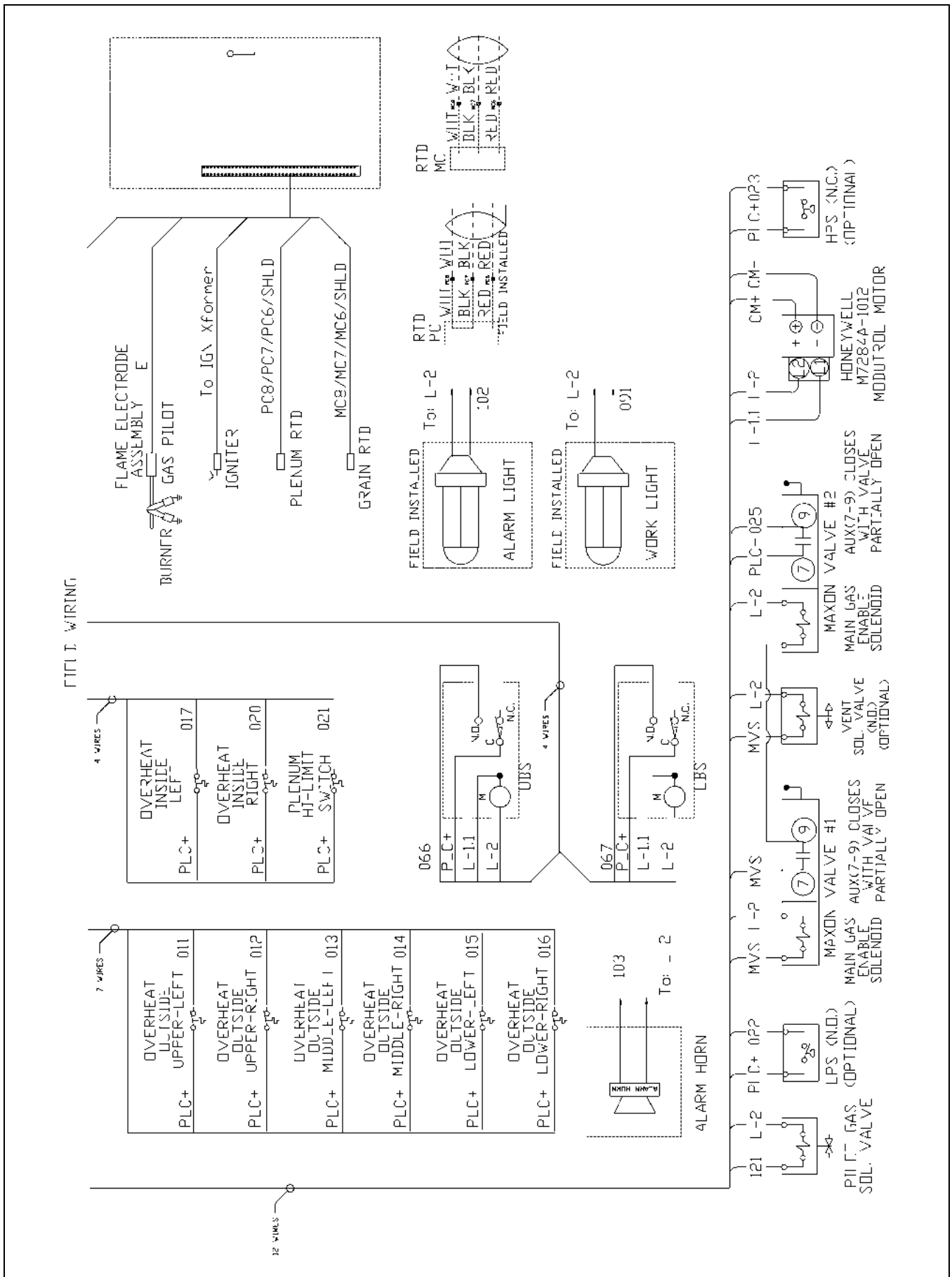

8. Tower Dryer - Domestic Wiring Diagrams

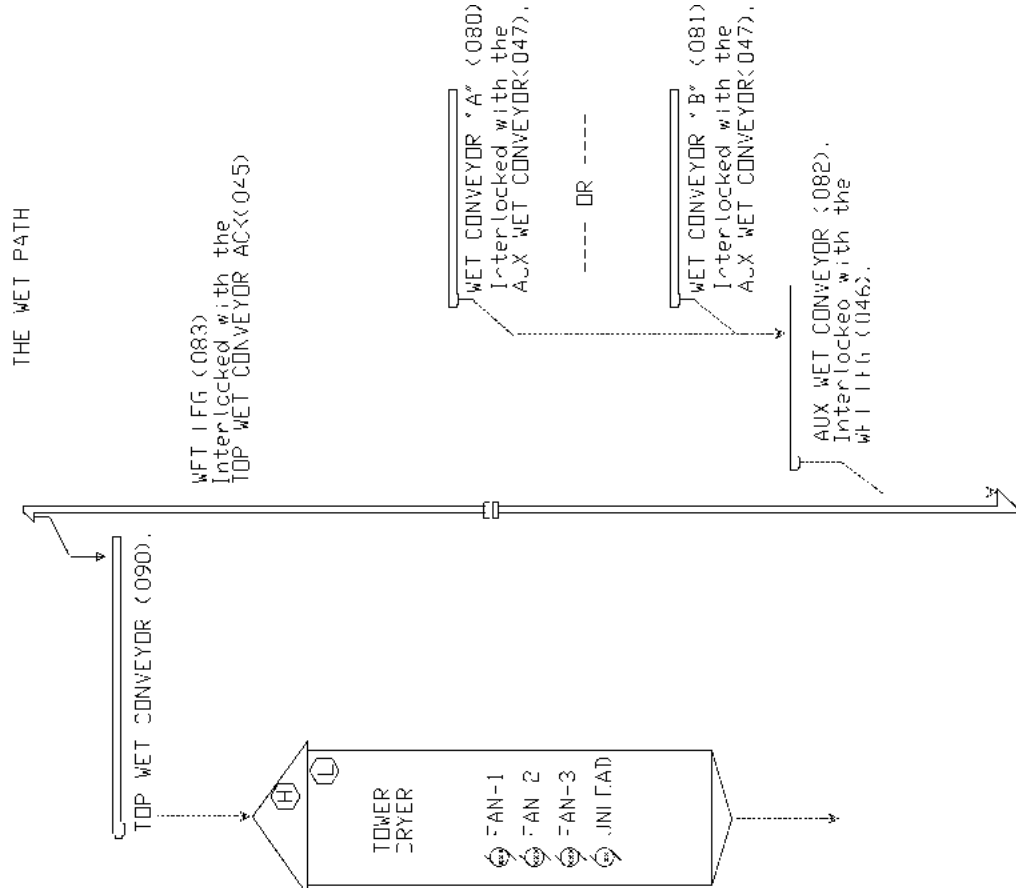
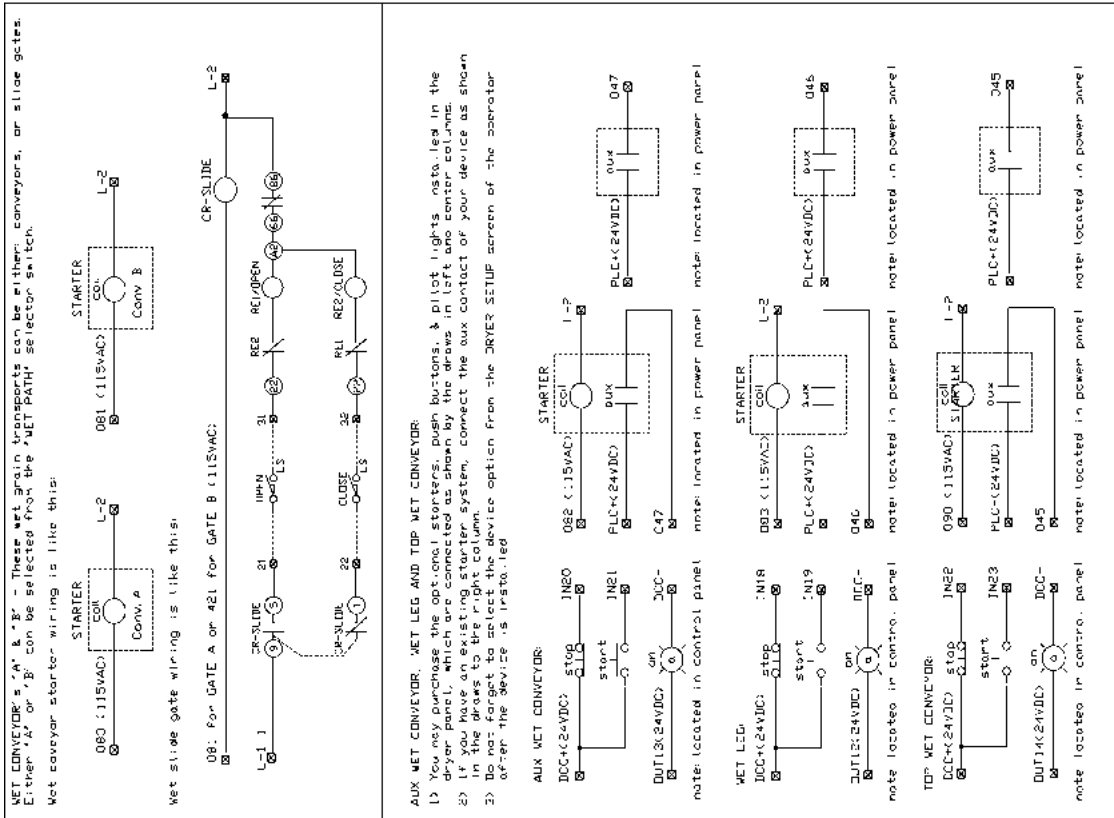

8. Tower Dryer - Domestic Wiring Diagrams

THE DRY PATH

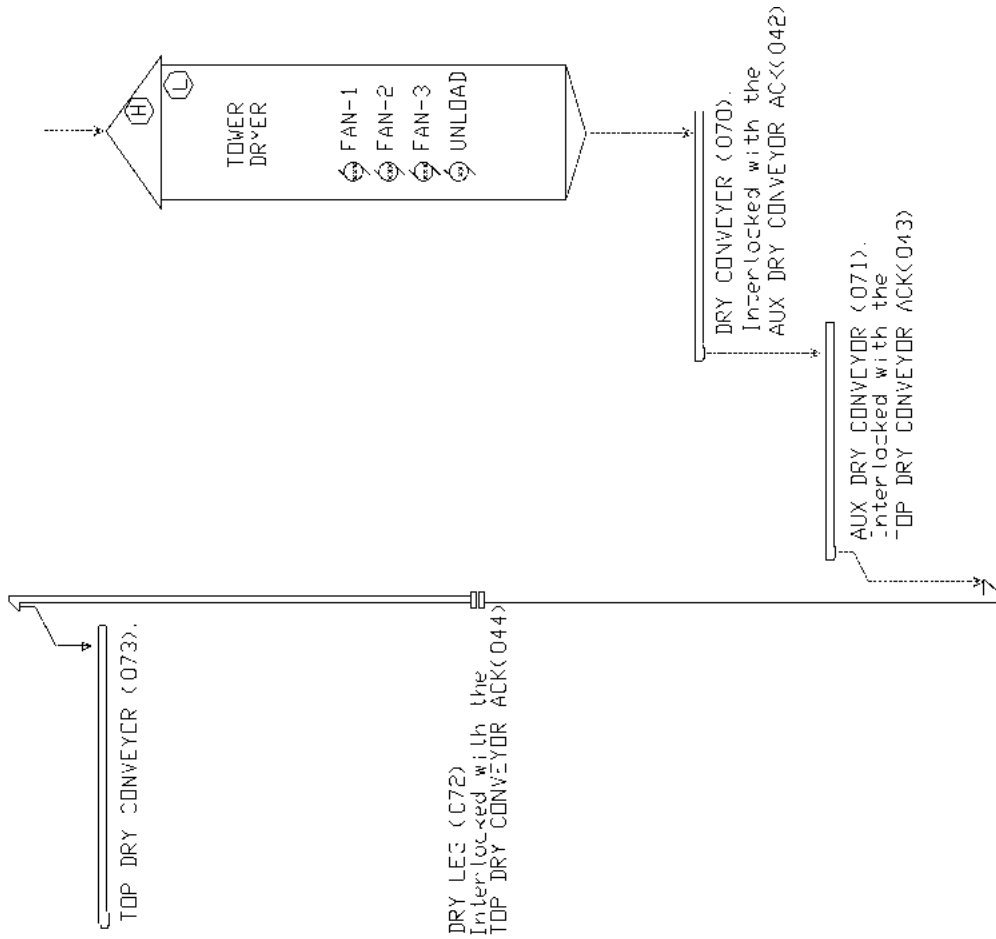

DRY CONVEYOR:
 This is the dry grain transport located directly under the dryer discharge hopper. All tower dryer control panels include a starter to control this function. Simply hook up the starter to the power supply and you are done. The Dry Conveyor Starter aux is the "un-sensitise" for the dryer unload. Please use this starter.

If you wish to add plug switches to the Dry Conveyor, remove the yellow jumper wire between PLC- and JCS, and install a N.L. dry contacts, in series between HLT & JCS.

Do not forget to select the DRY CONVEYOR and DRY PATH PLUG options from the DRYER SETUP screen of the operator interface if these device are installed.

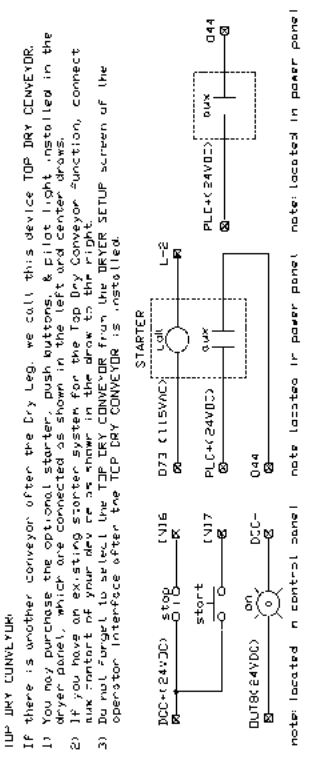
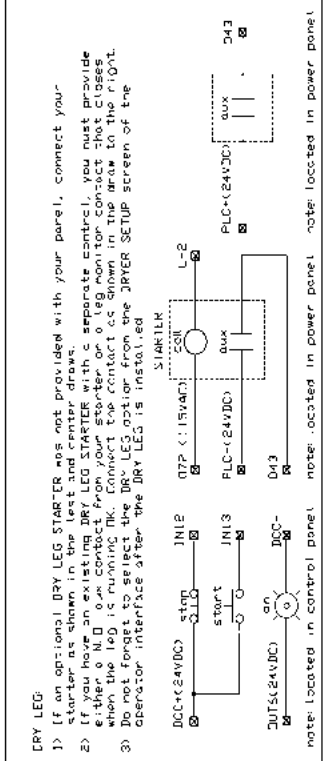
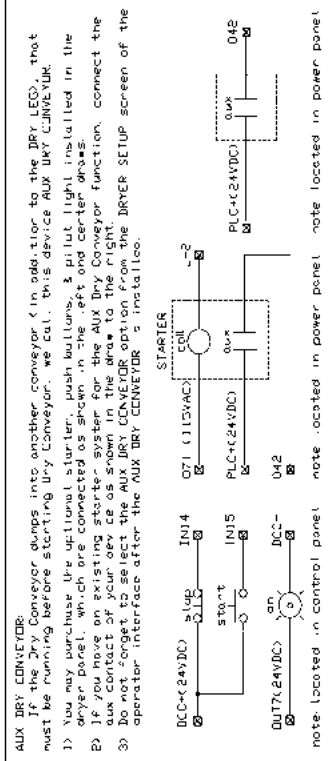

8. Tower Dryer - Domestic Wiring Diagrams

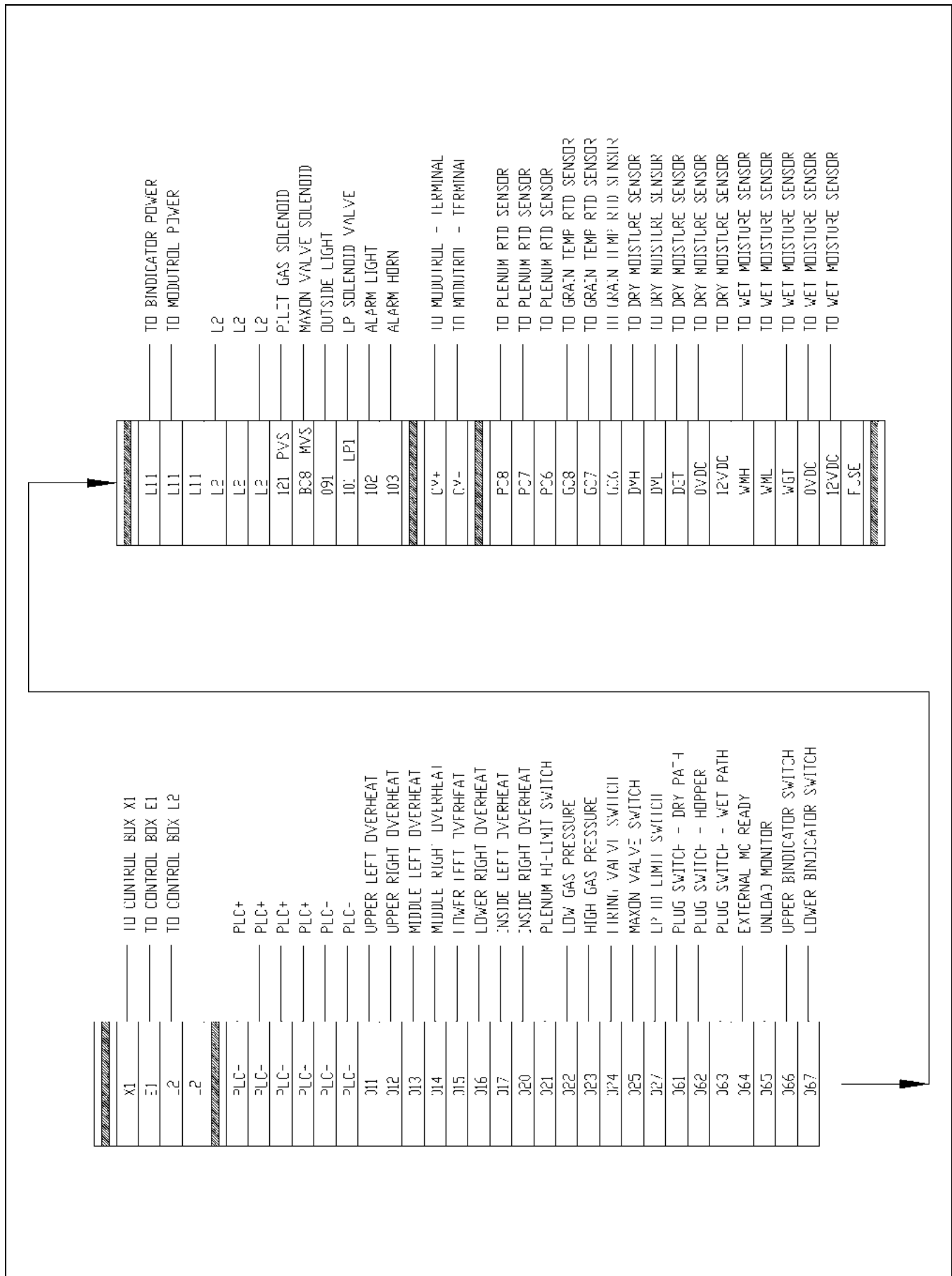

NOTES



Tower Dryer Domestic 4-Fan Wiring Diagrams

8. Tower Dryer - Domestic Wiring Diagrams

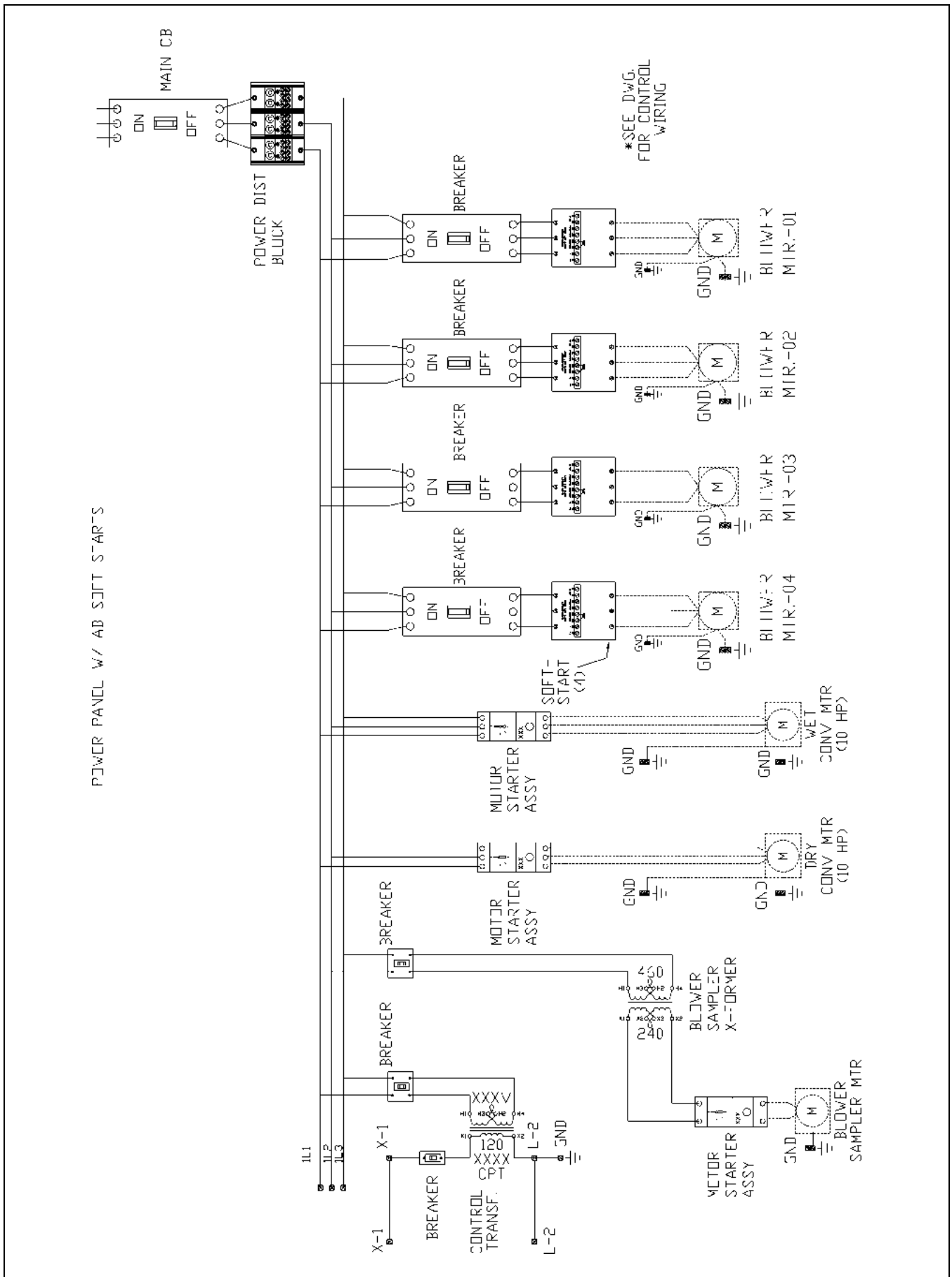

8. Tower Dryer - Domestic Wiring Diagrams

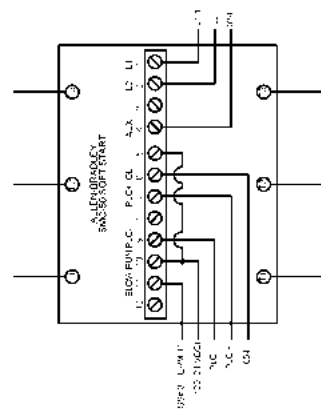

BLOWER #1

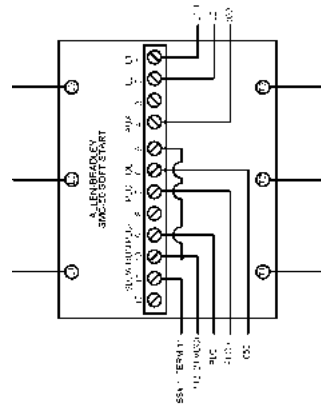

BLOWER #2

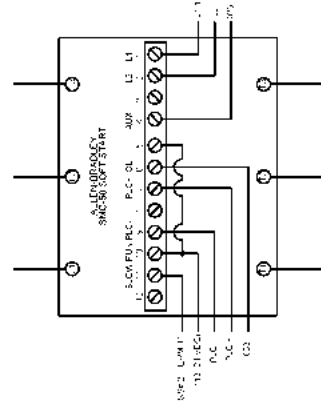

BLOWER #3

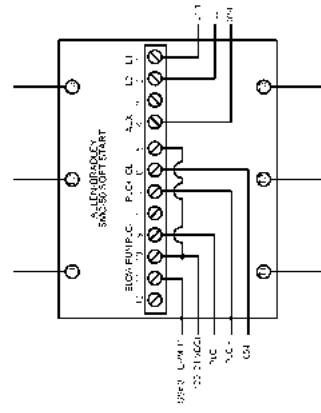

BLOWER #4

- NOTES:
1. SMC-50 SOFT STARTS CONTAIN A LOGIC PROGRAM THAT MUST BE LOADED VIA GT3-1809 INTERFACE MODULE.
 2. BLOWER 1 WIRING DIFFERS FROM OTHERS. TERM 11 JUMPERED TO TERM 10.
 3. P335 IS THE SLOW SPEED START DELAY. SET AS FOLLOWS:
 BLOWER 1 = 0000
 BLOWER 2 = 7000
 BLOWER 3 = 14000
 BLOWER 4 = 21000

8. Tower Dryer - Domestic Wiring Diagrams

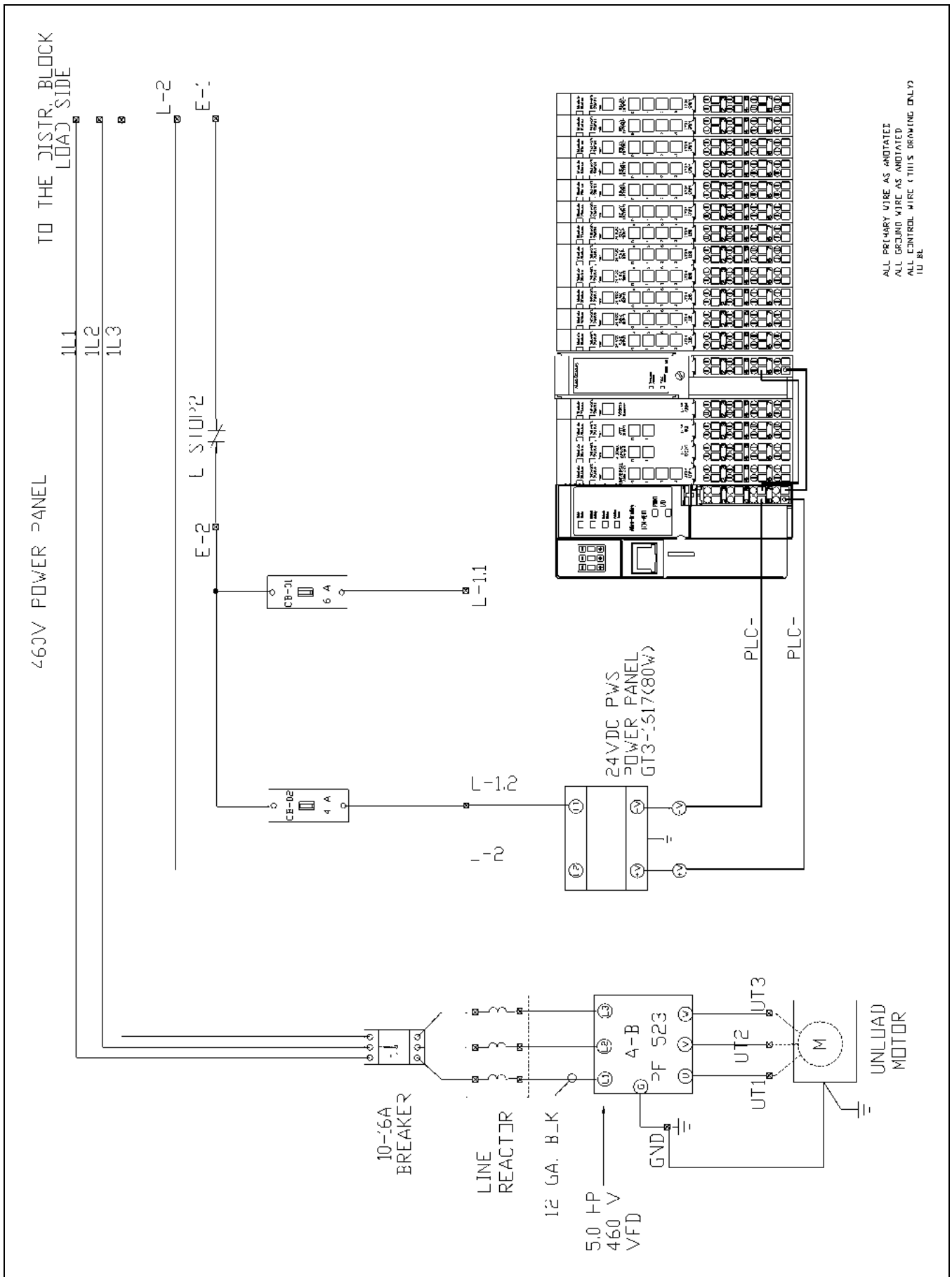

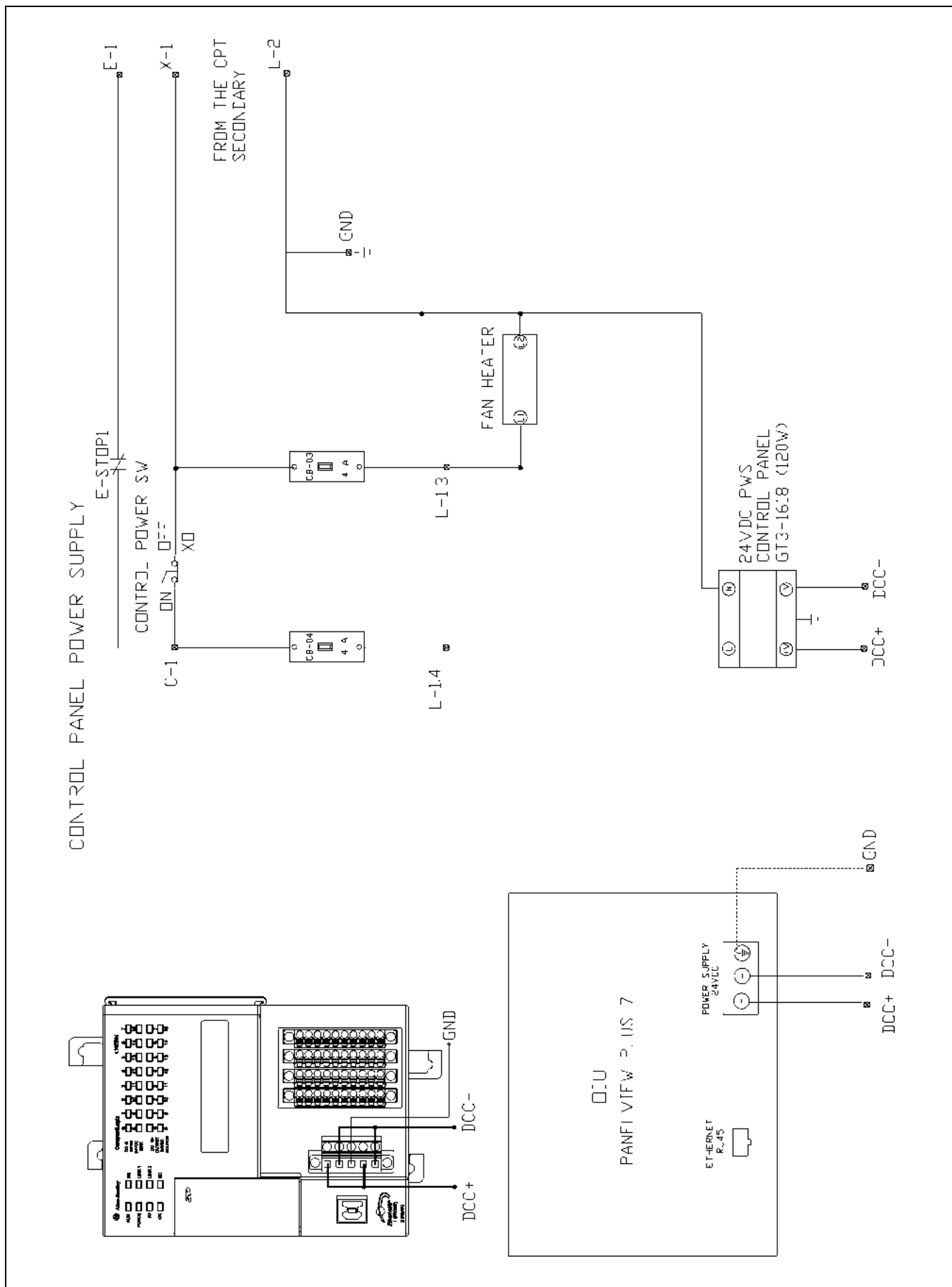

8. Tower Dryer - Domestic Wiring Diagrams

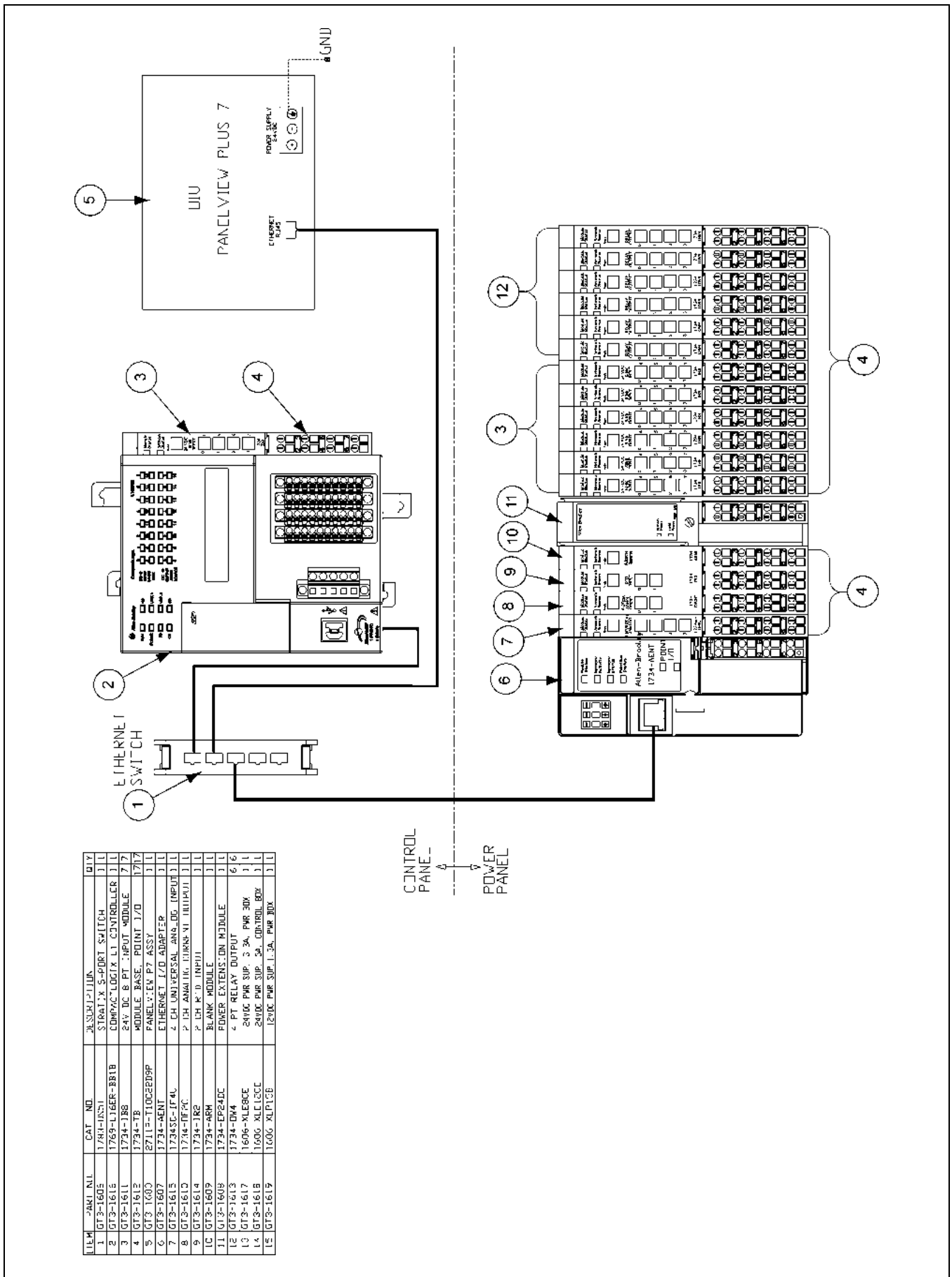

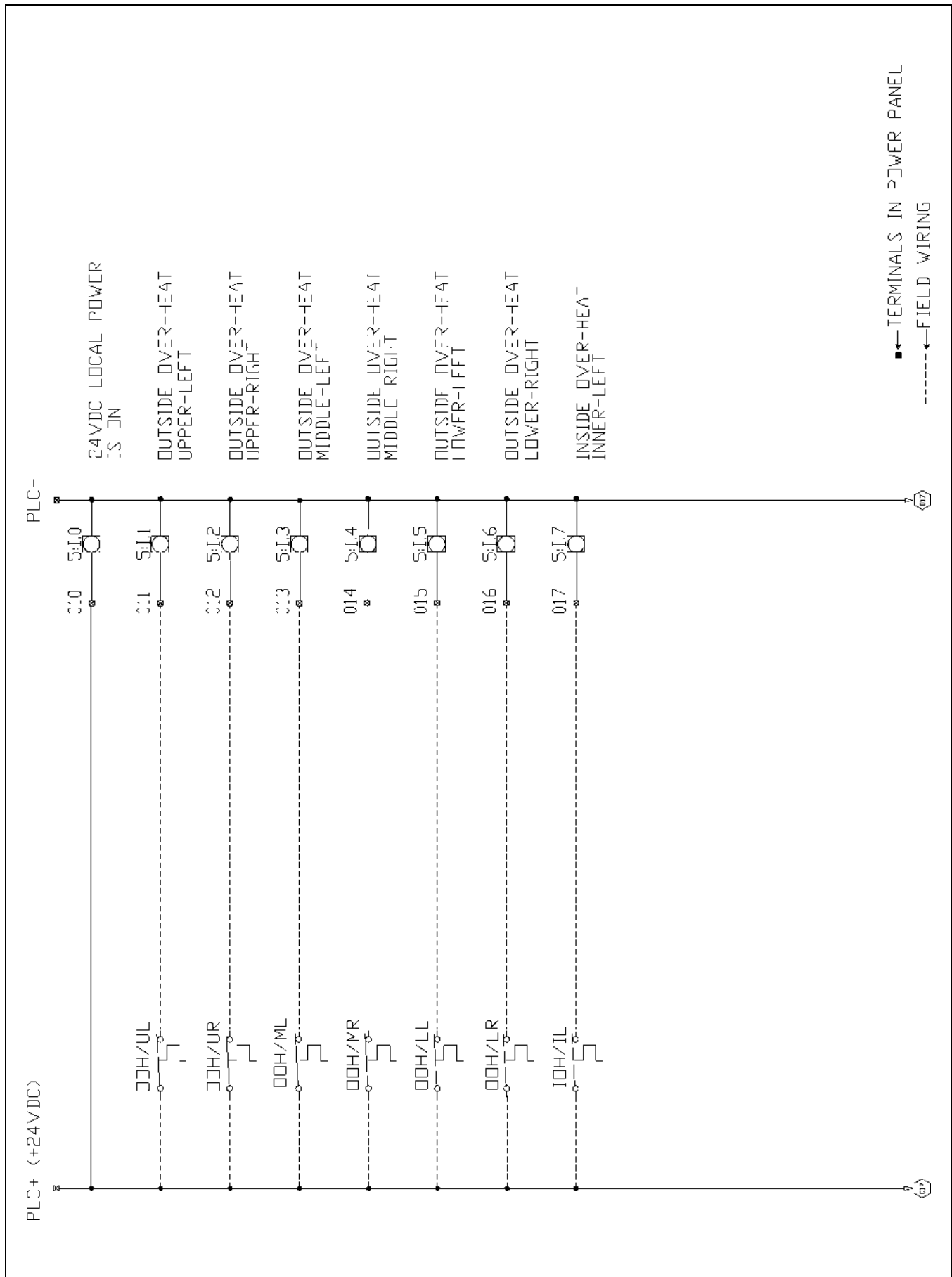

8. Tower Dryer - Domestic Wiring Diagrams

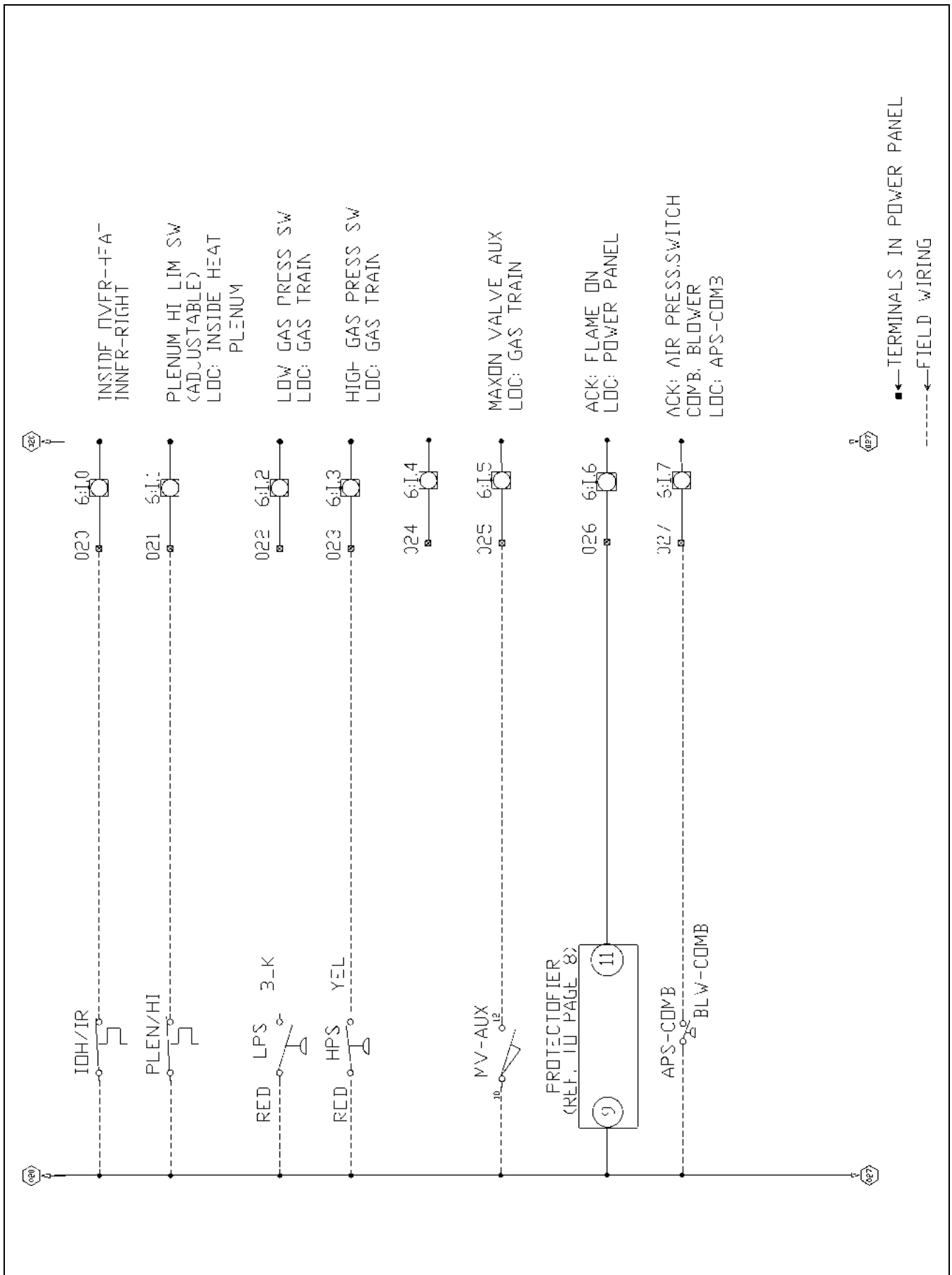

8. Tower Dryer - Domestic Wiring Diagrams

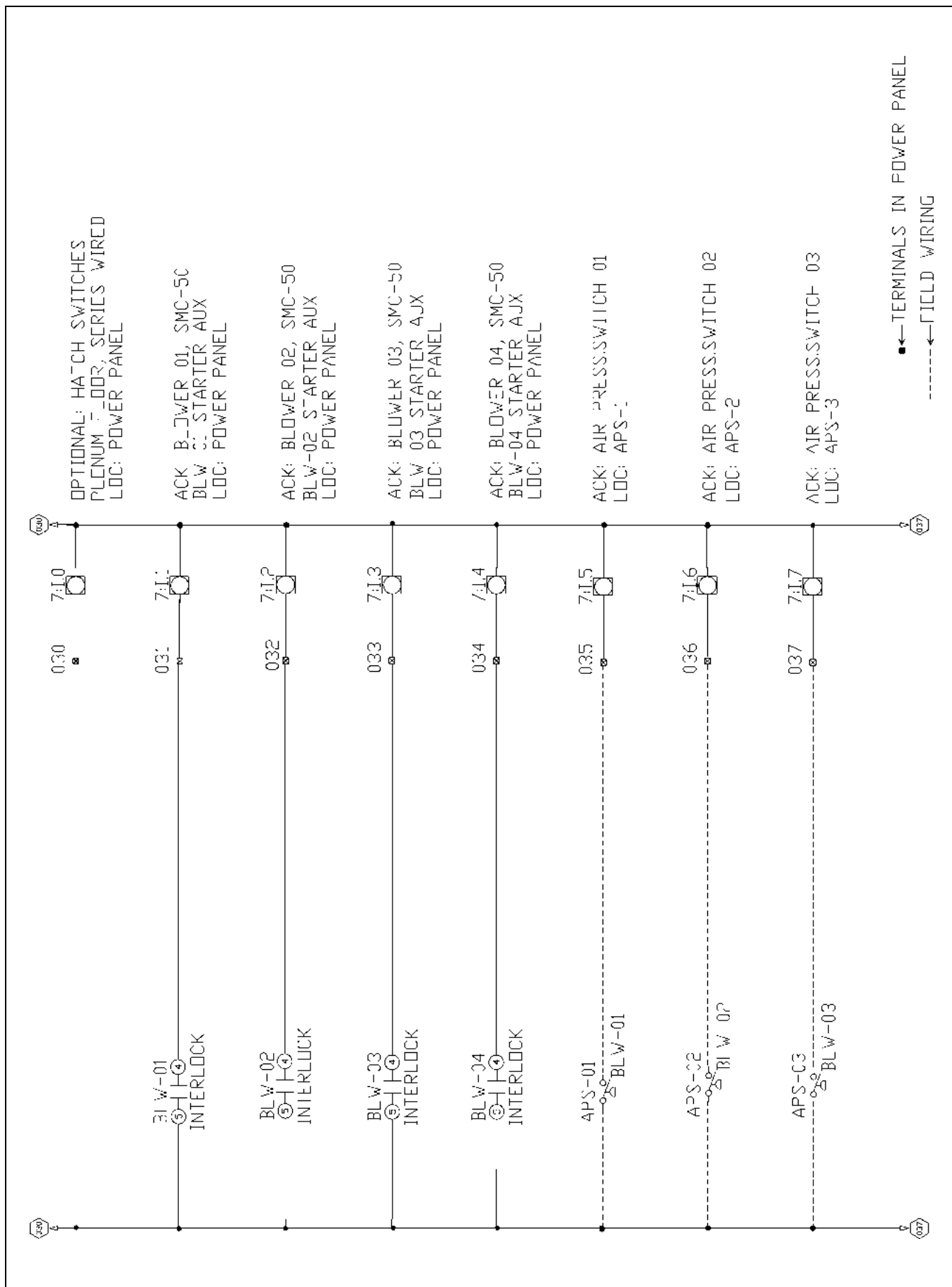

8. Tower Dryer - Domestic Wiring Diagrams

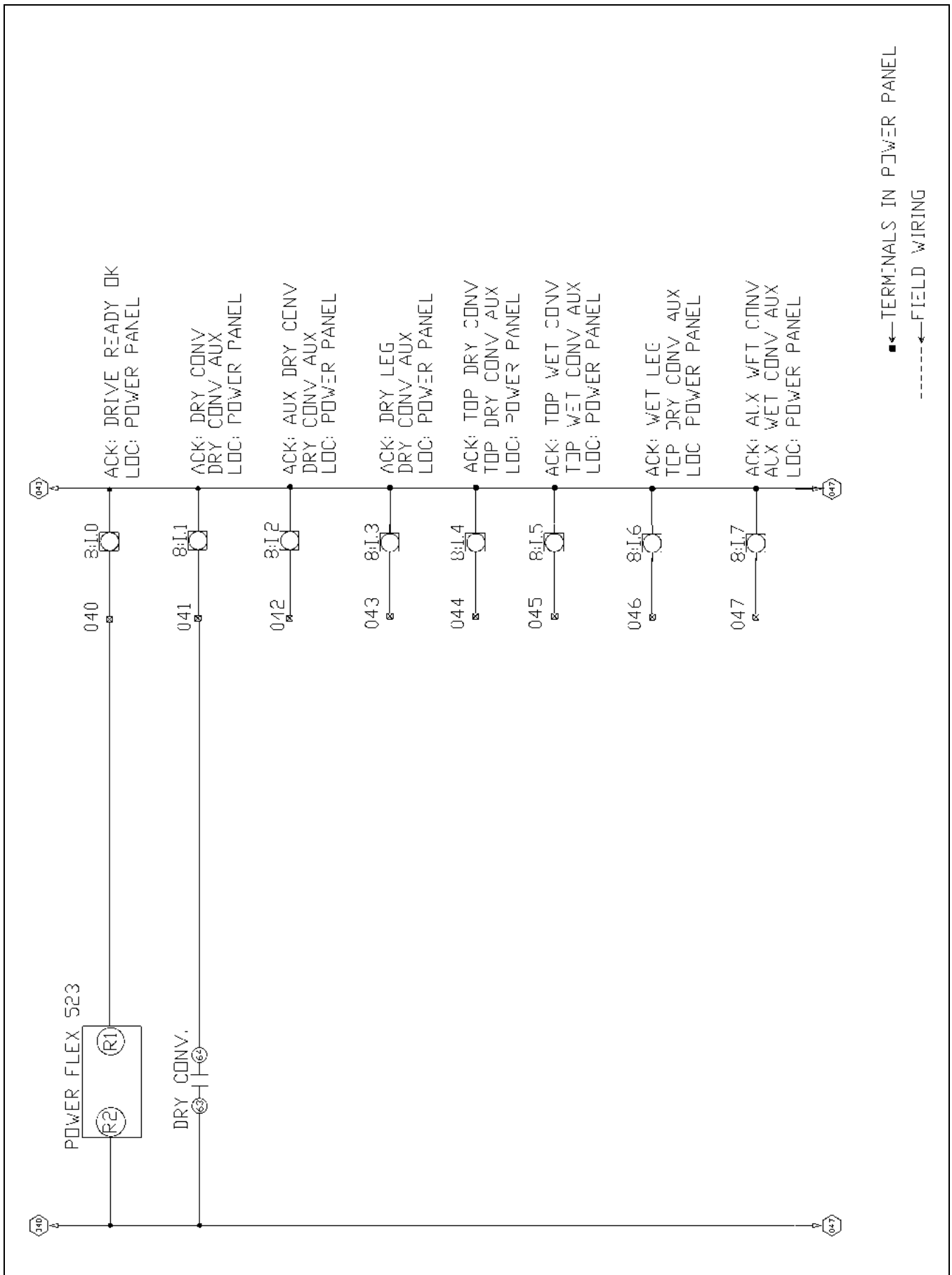

8. Tower Dryer - Domestic Wiring Diagrams

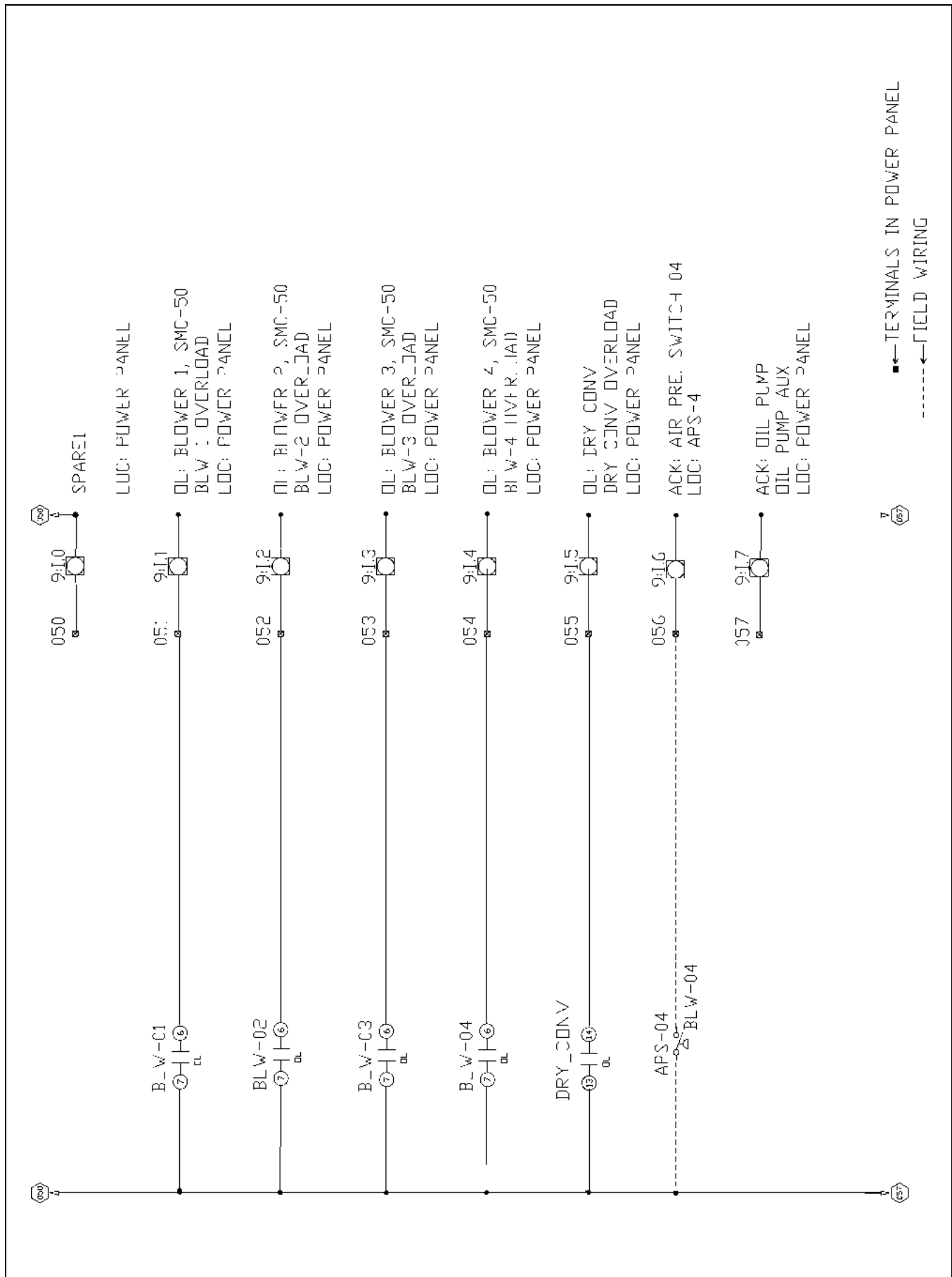

8. Tower Dryer - Domestic Wiring Diagrams

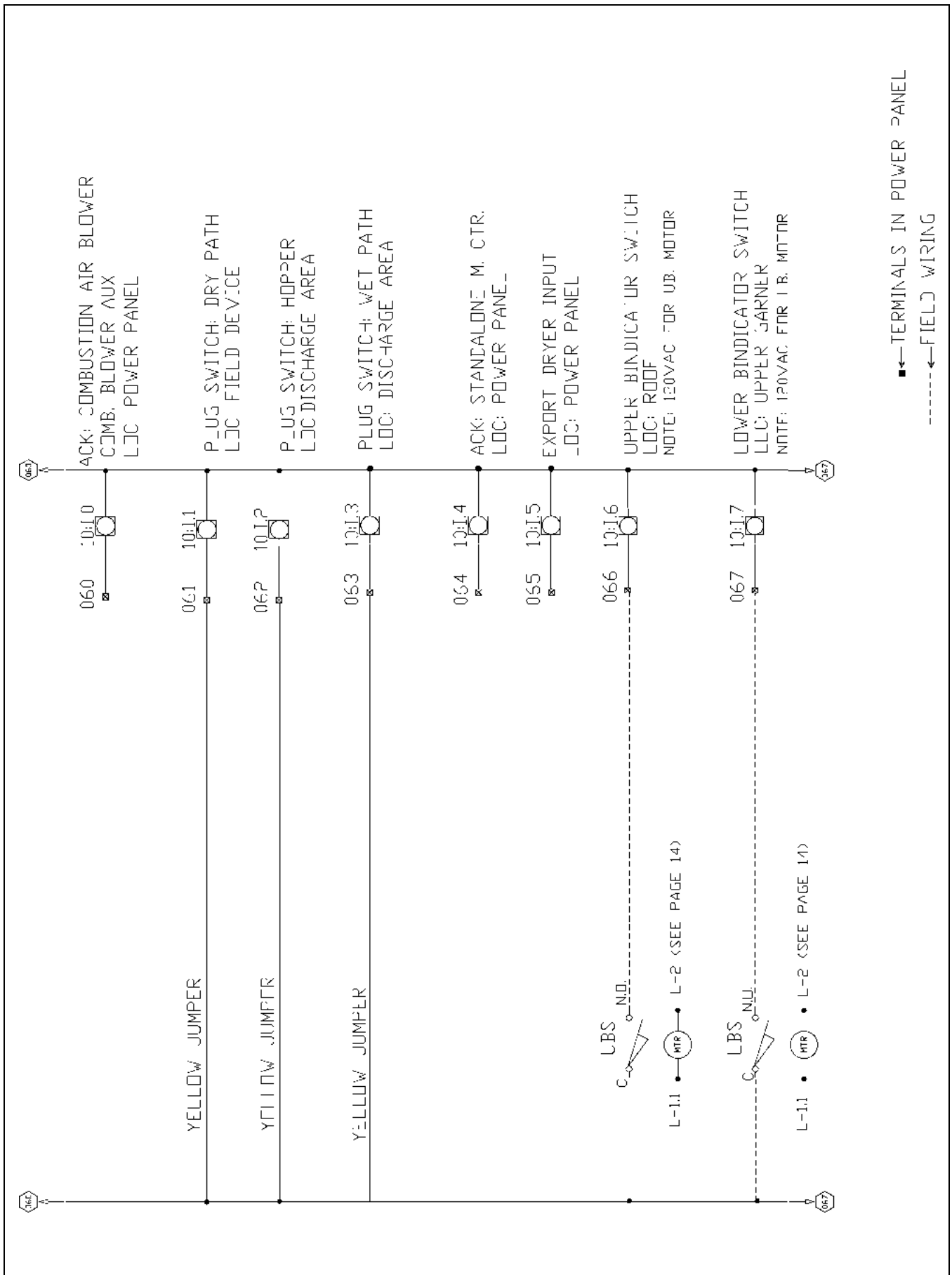

8. Tower Dryer - Domestic Wiring Diagrams

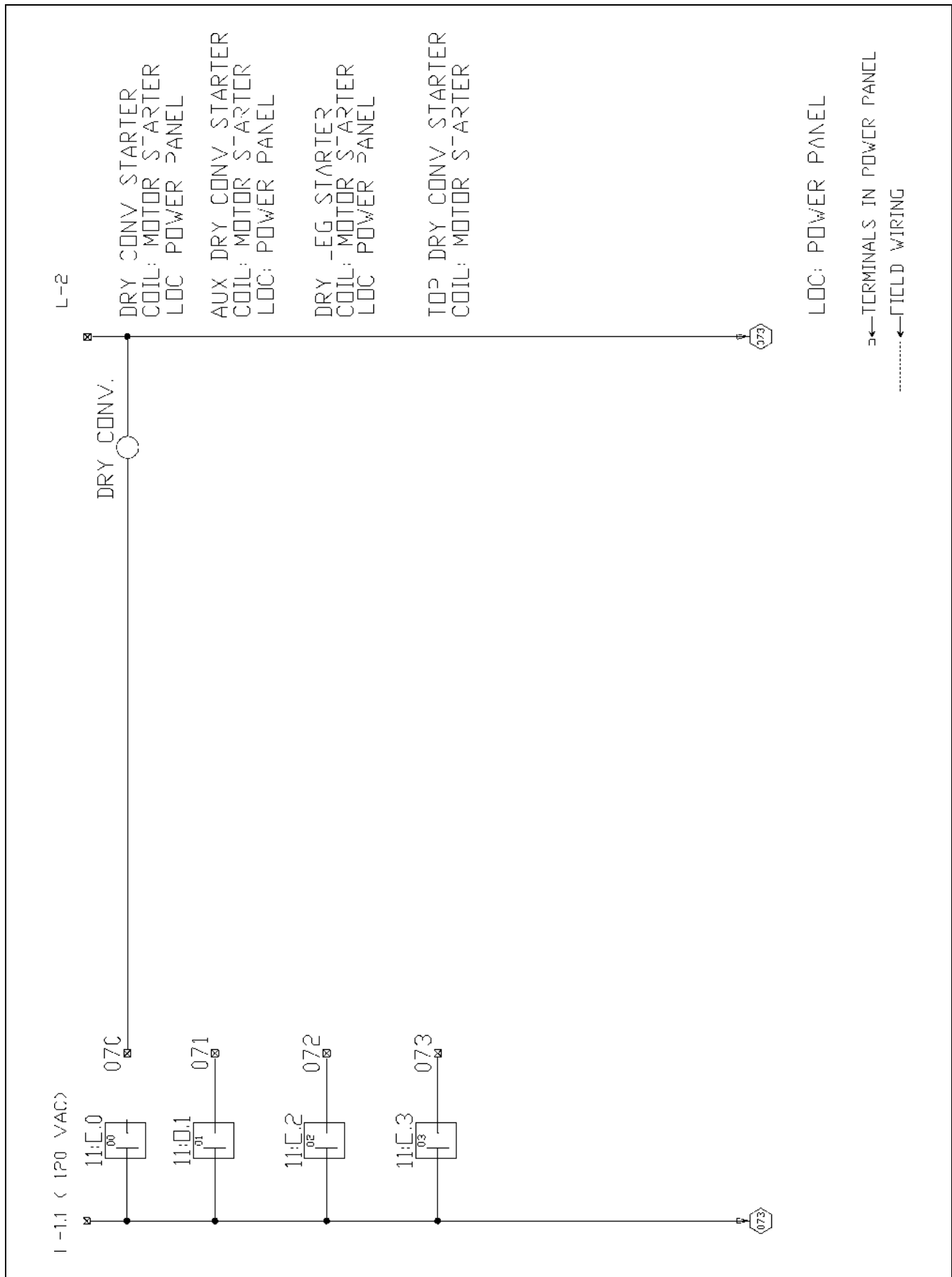

8. Tower Dryer - Domestic Wiring Diagrams

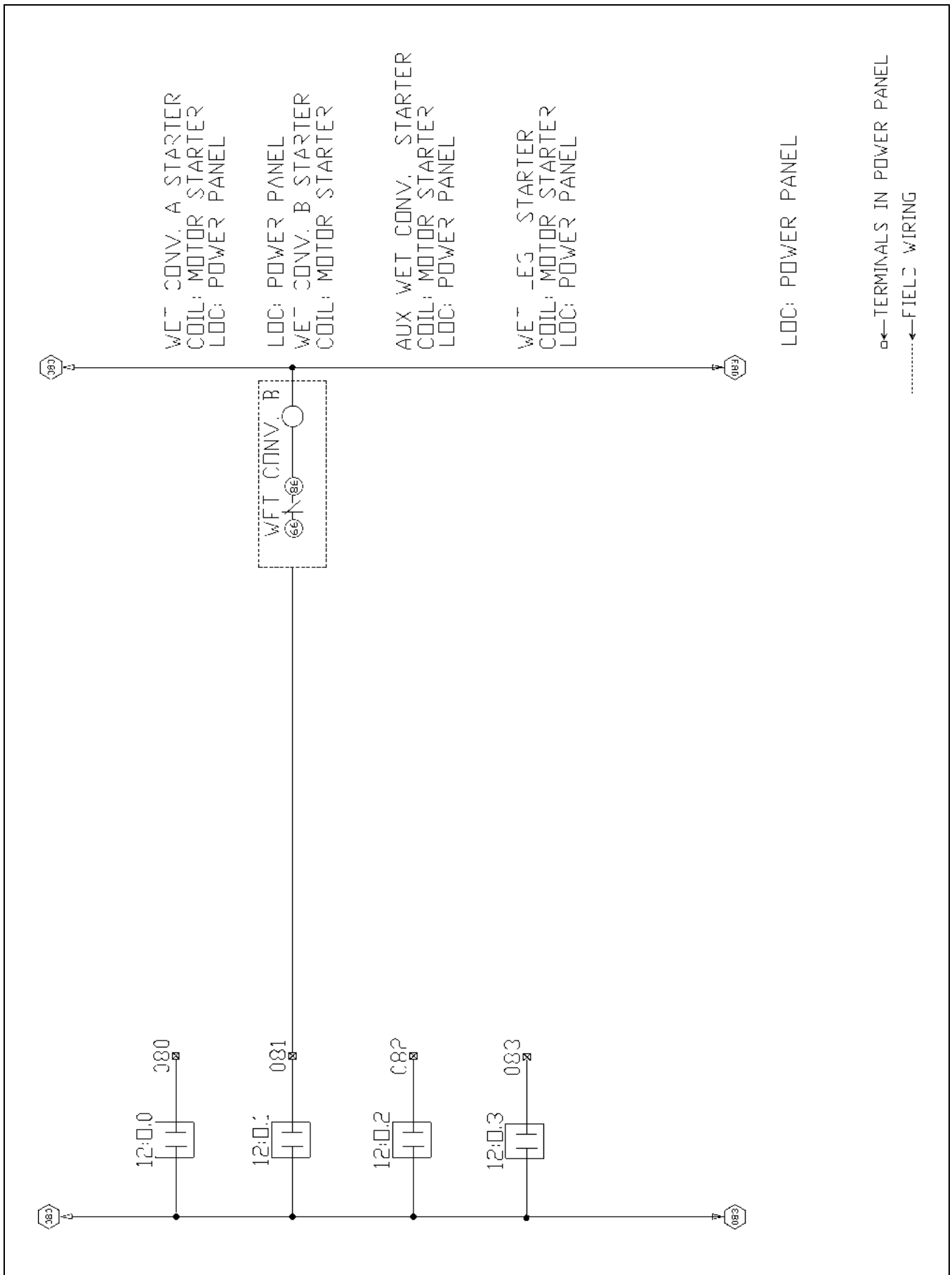

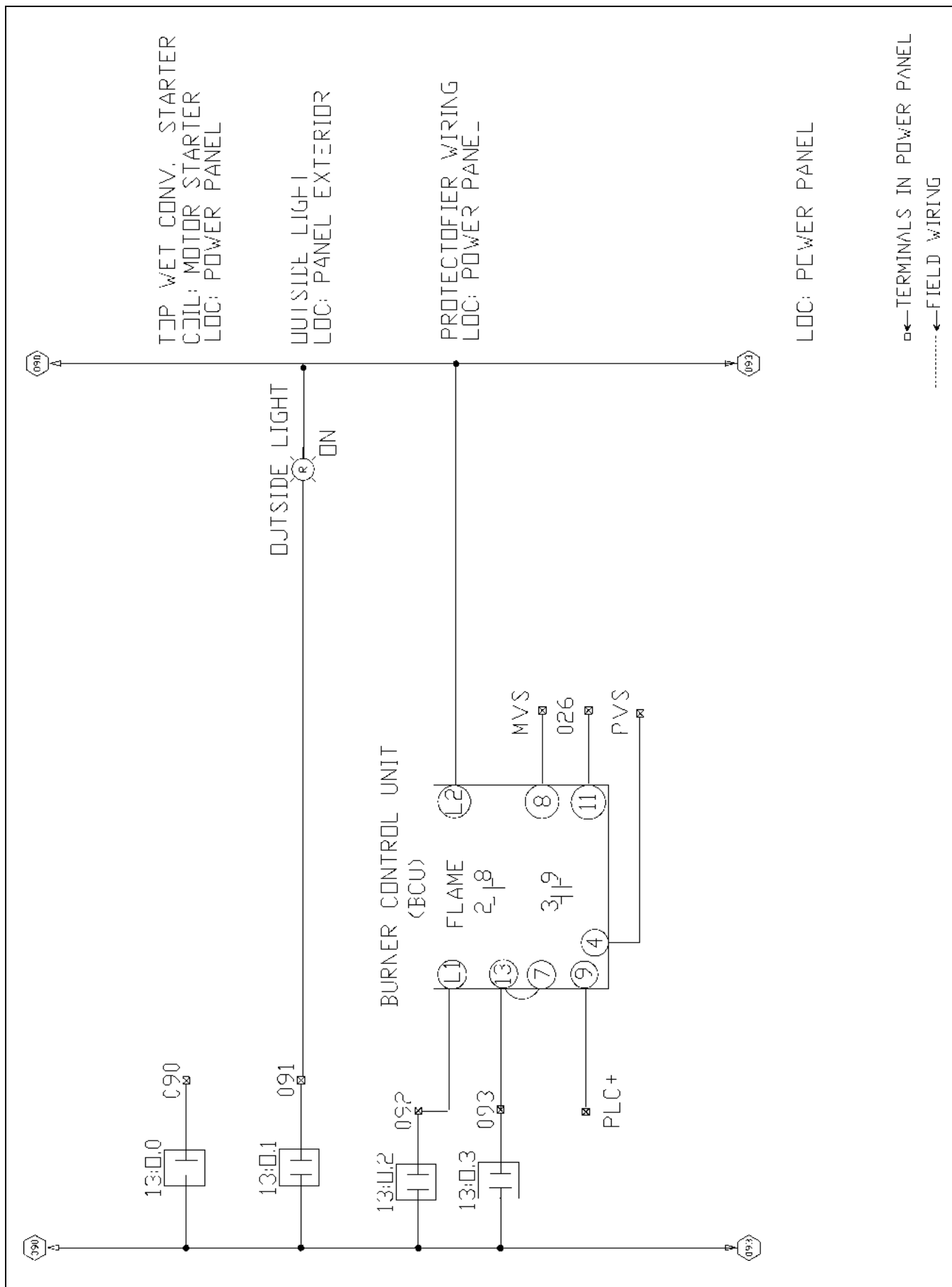

8. Tower Dryer - Domestic Wiring Diagrams

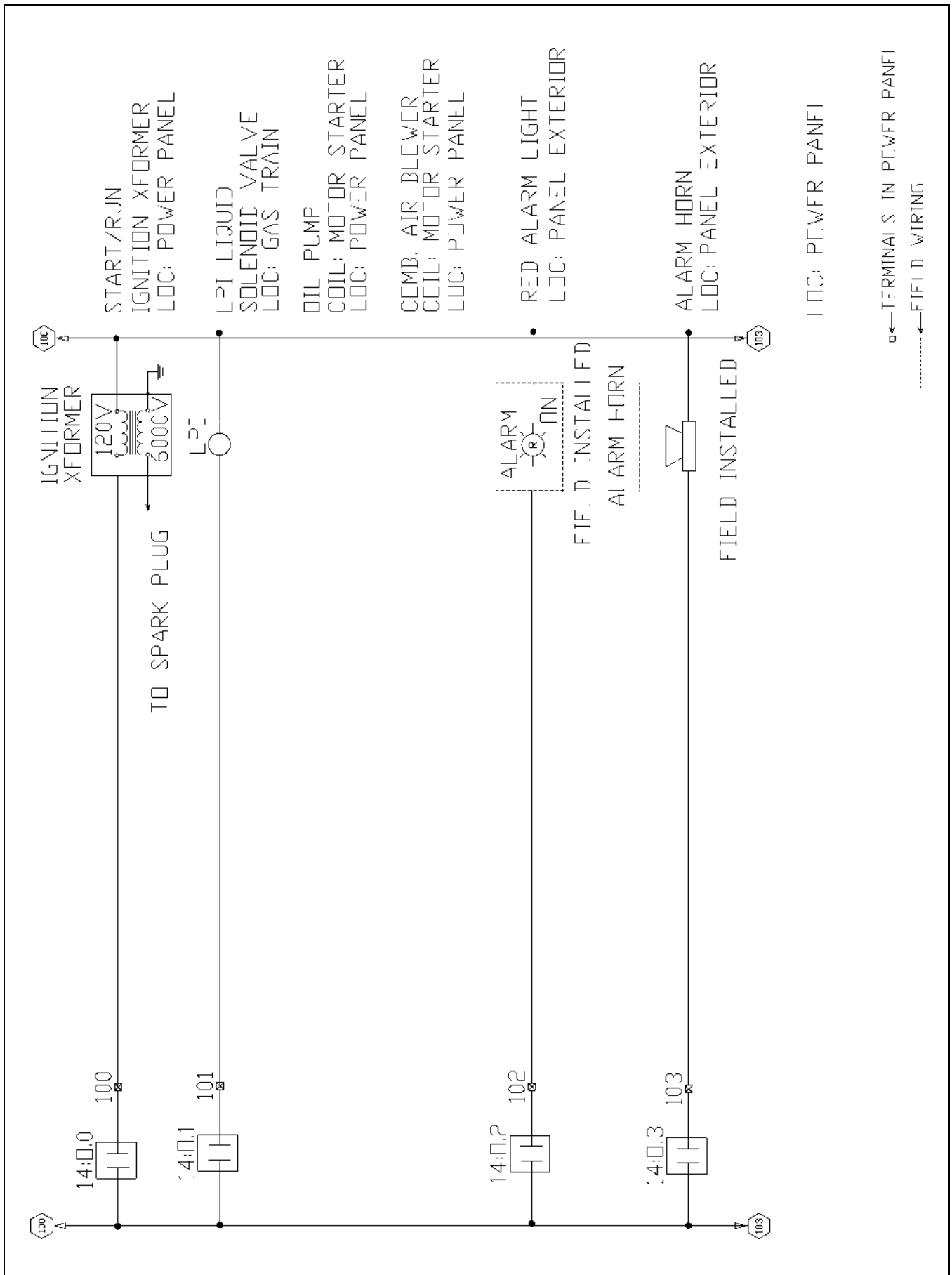

8. Tower Dryer - Domestic Wiring Diagrams

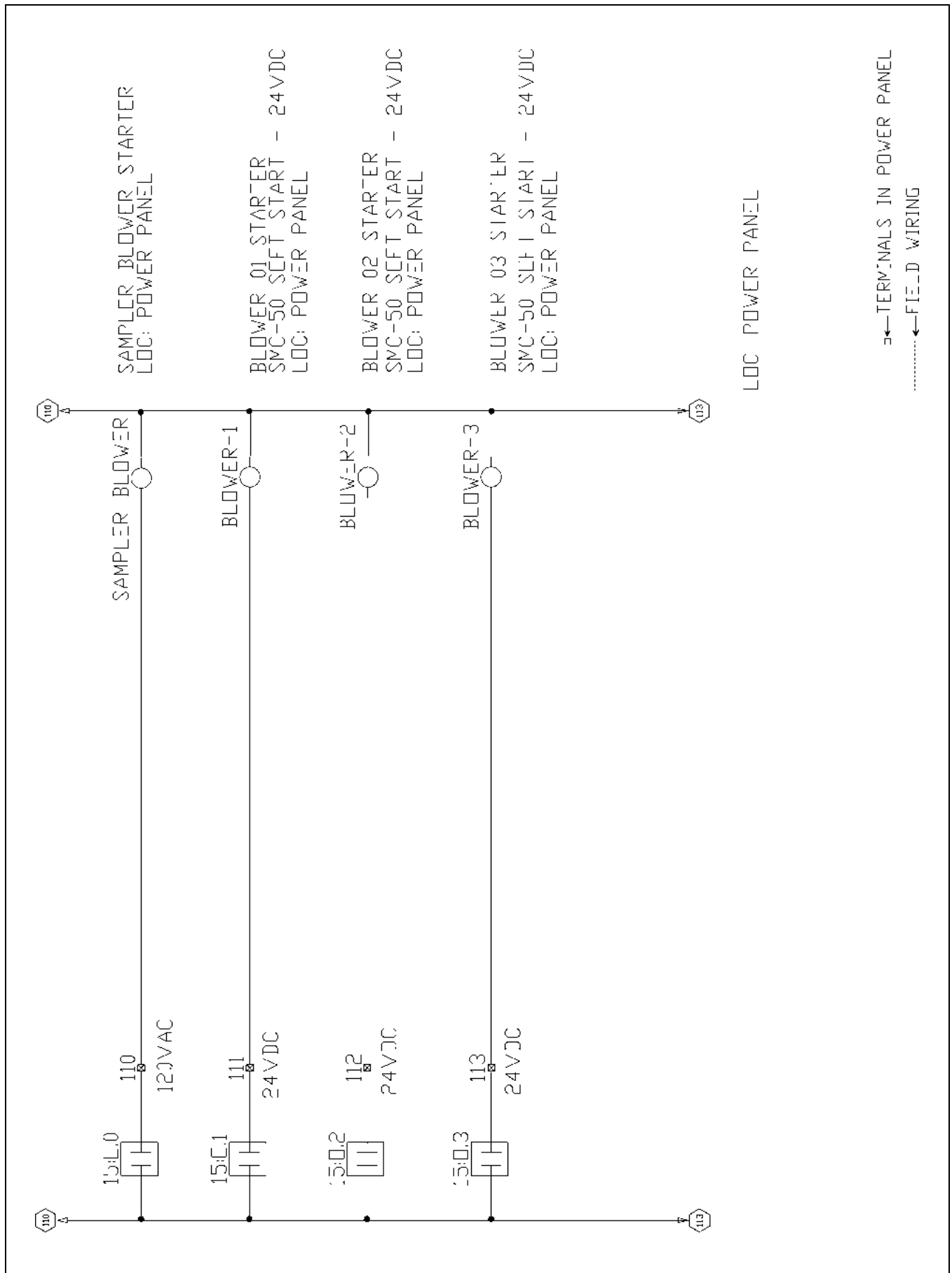

8. Tower Dryer - Domestic Wiring Diagrams

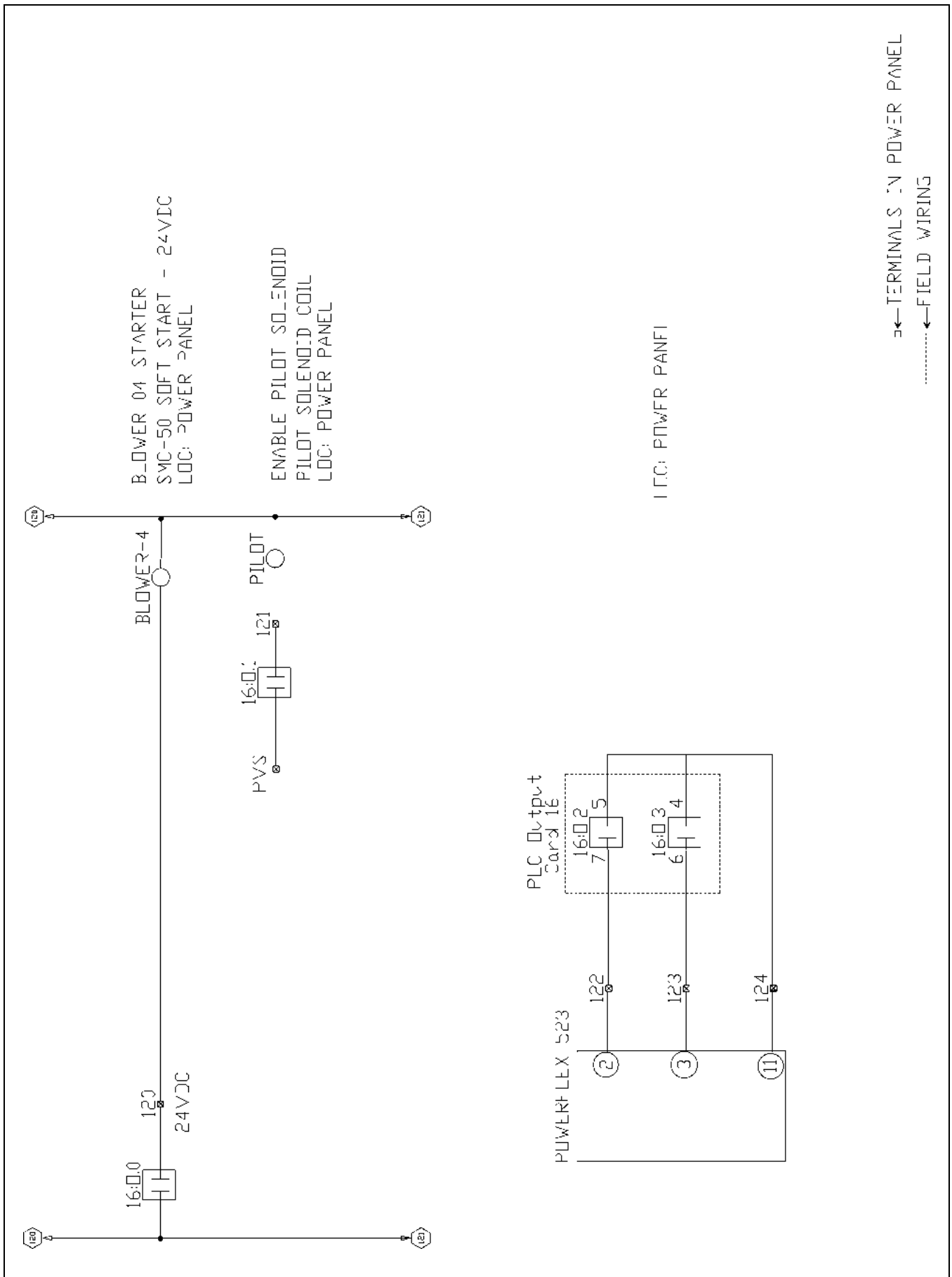

8. Tower Dryer - Domestic Wiring Diagrams

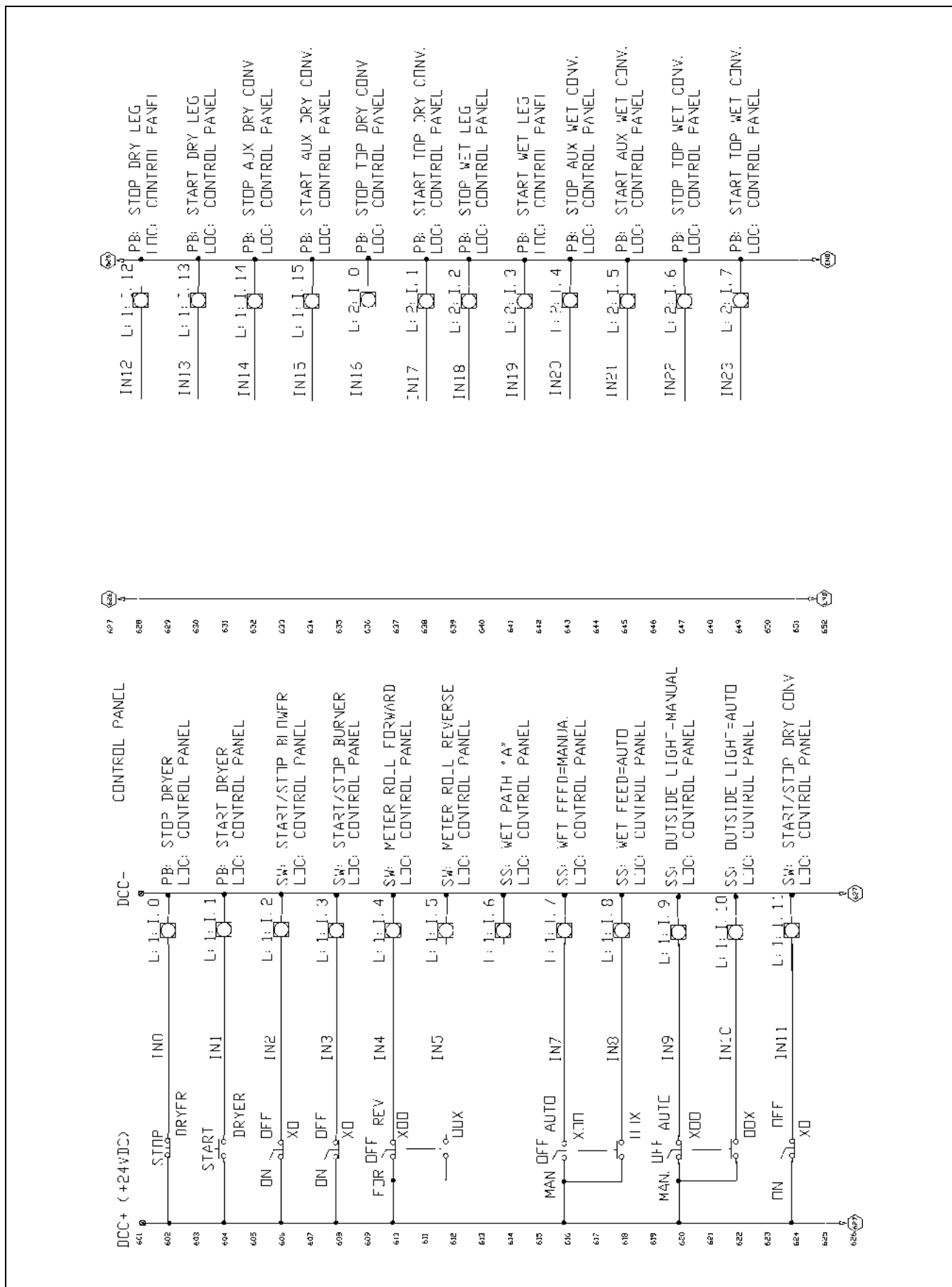

8. Tower Dryer - Domestic Wiring Diagrams

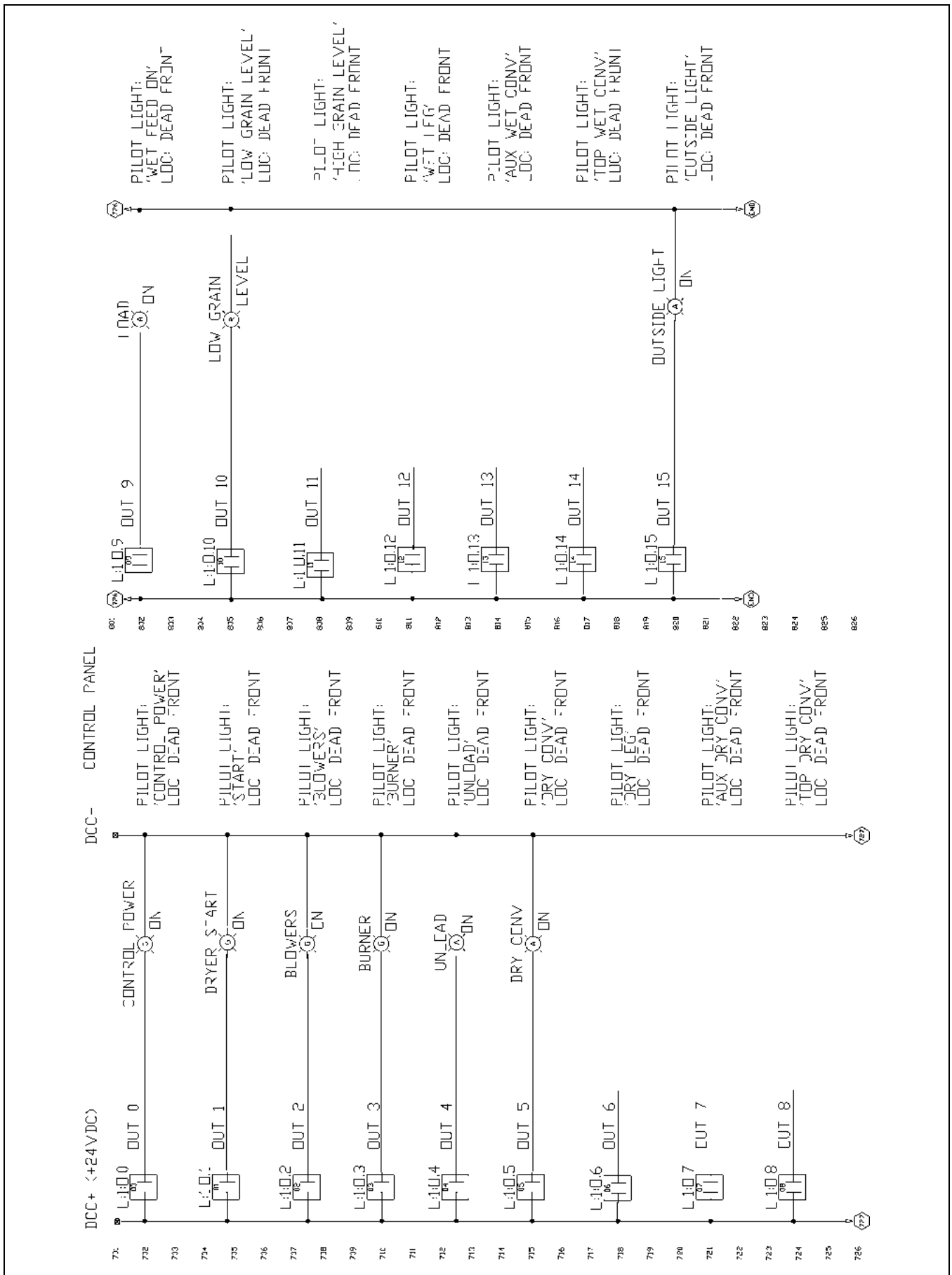

8. Tower Dryer - Domestic Wiring Diagrams

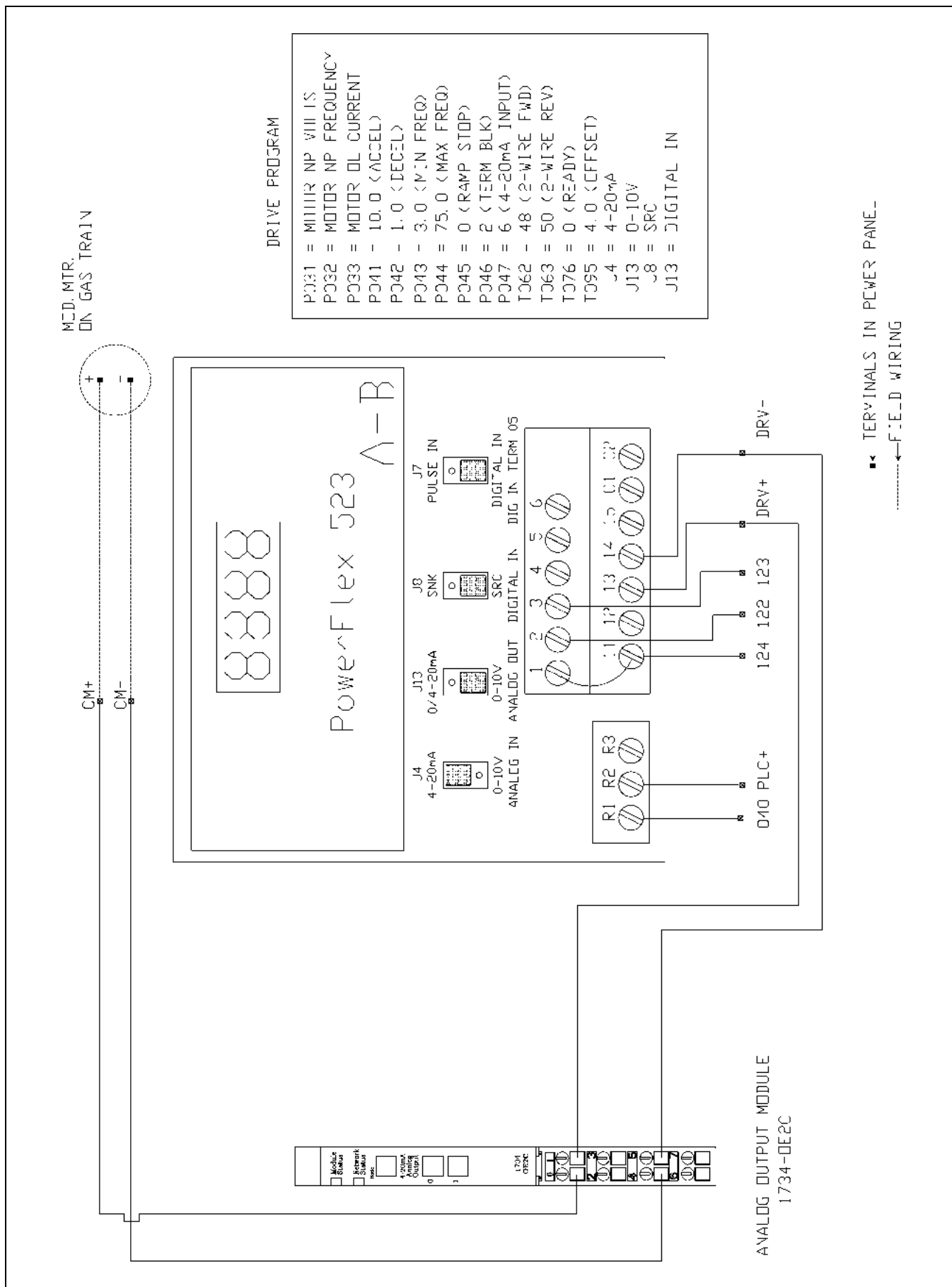

8. Tower Dryer - Domestic Wiring Diagrams

* MOUNT THE WCT SENSOR ON THE SIDE WALL OF THE CORNER BIN, 1'1" BELOW THE LOWER INDICATOR

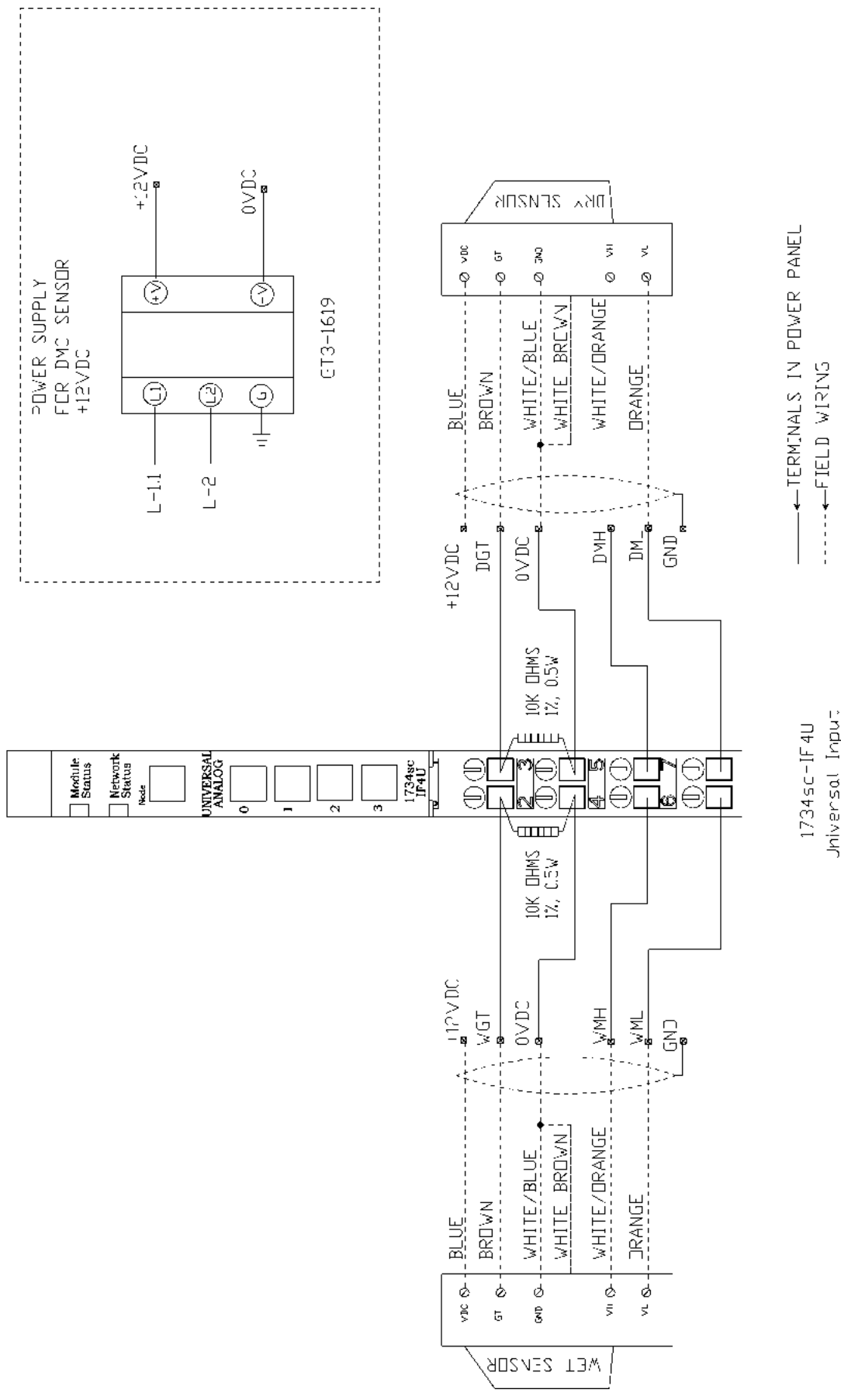

8. Tower Dryer - Domestic Wiring Diagrams

** MOUNT THE GRAIN RTD 3FT ABOVE THE END OF THE DRYING SECTION

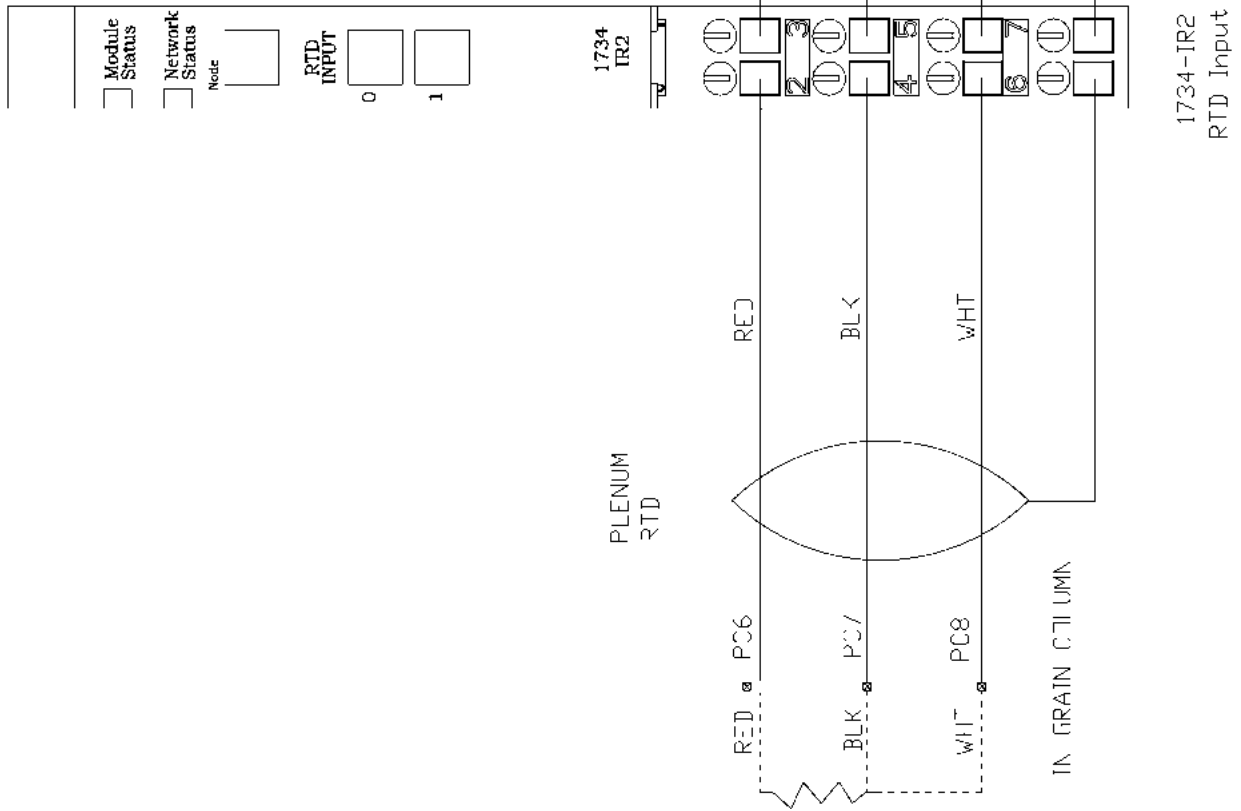

8. Tower Dryer - Domestic Wiring Diagrams

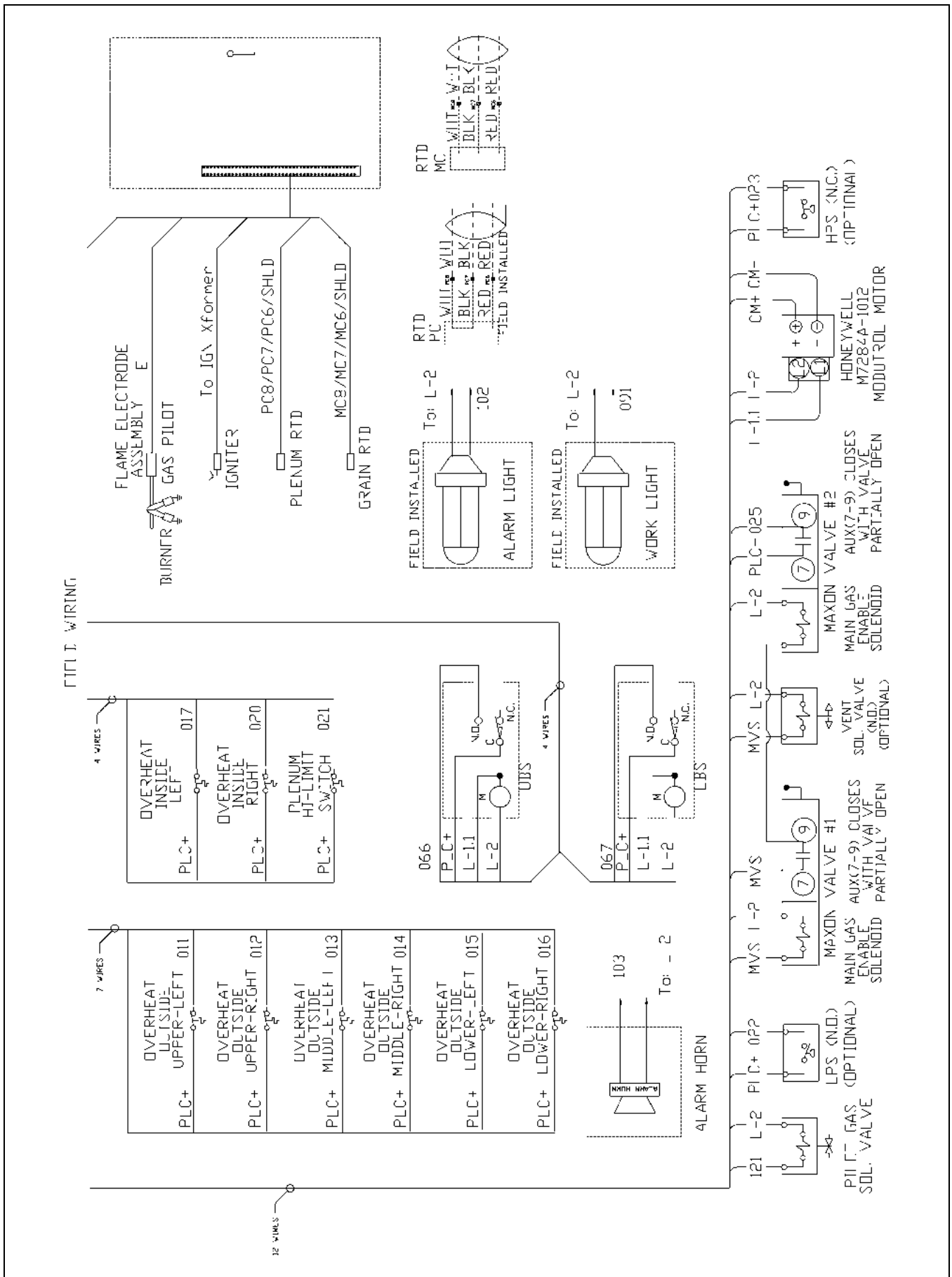

8. Tower Dryer - Domestic Wiring Diagrams

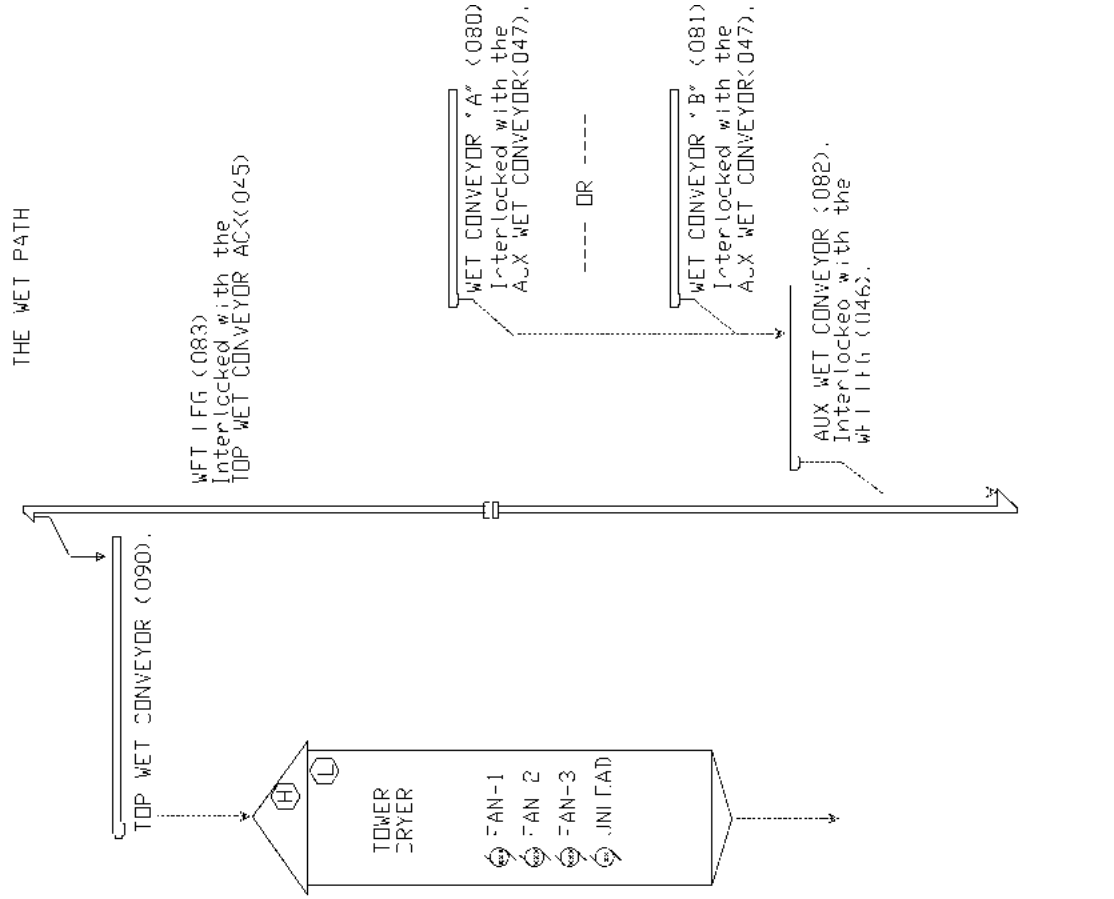
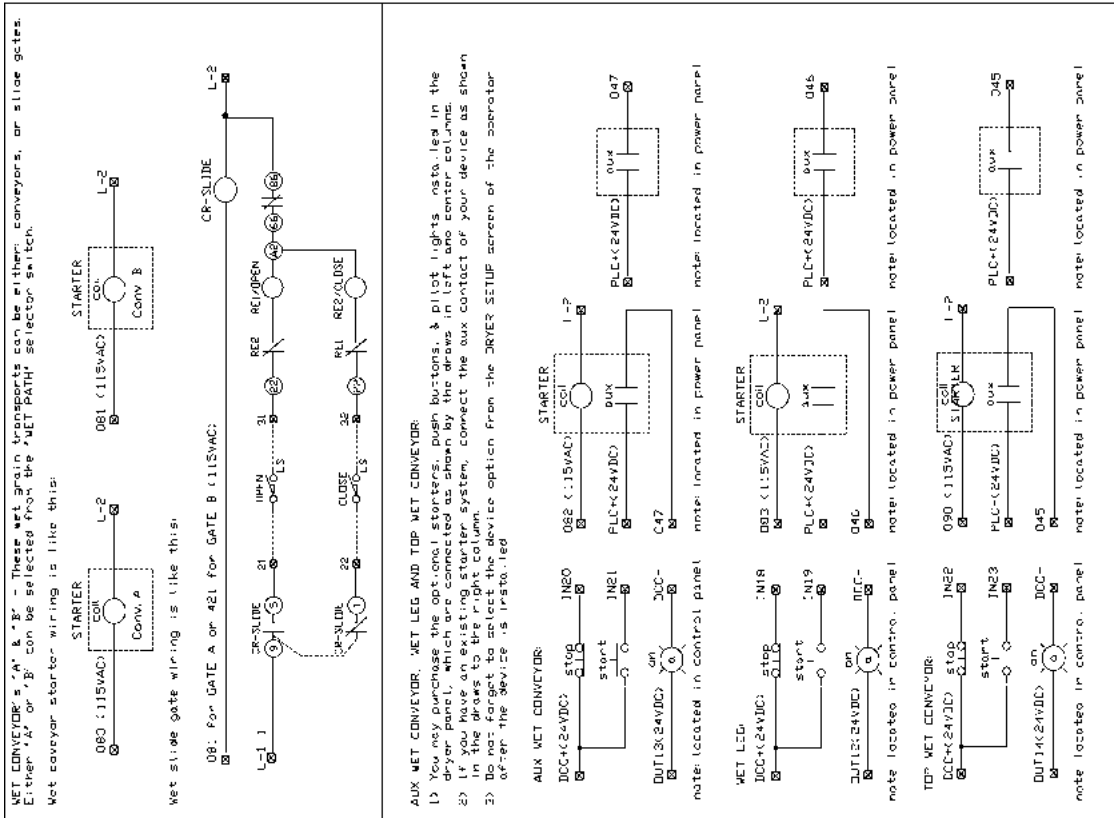

8. Tower Dryer - Domestic Wiring Diagrams

THE DRY PATH

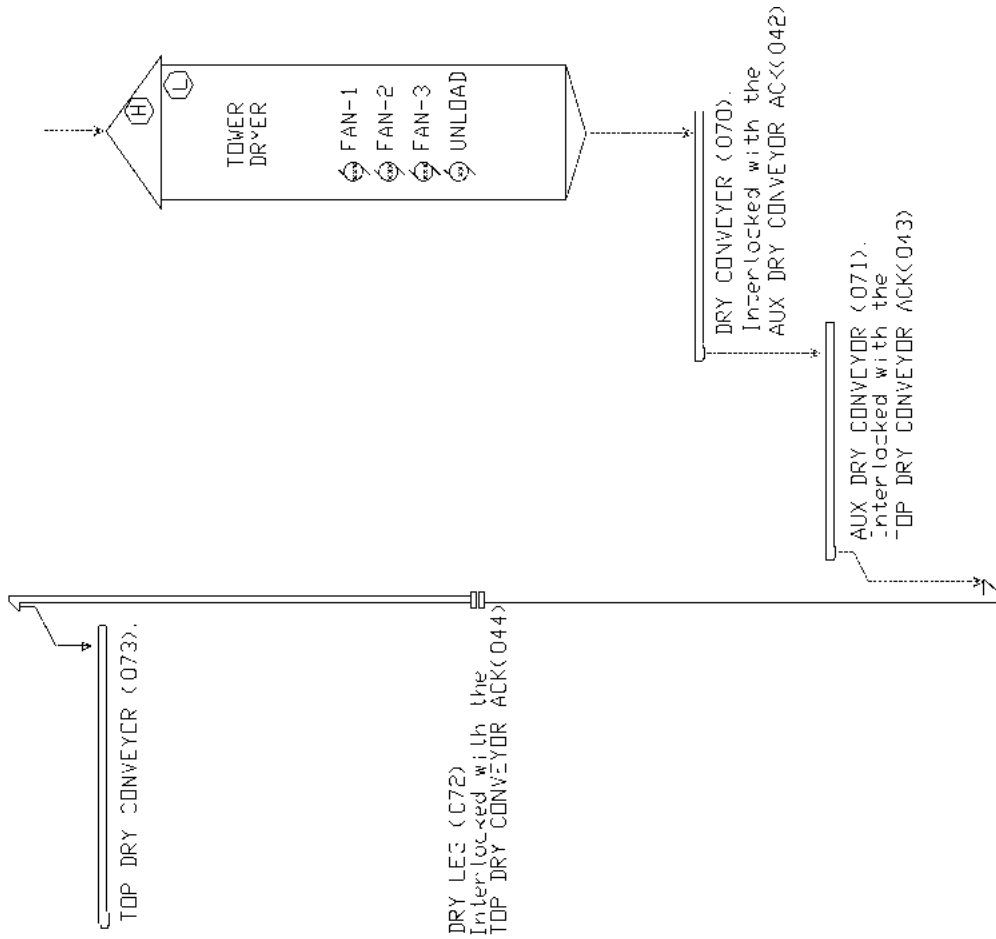

DRY CONVEYOR:
 This is the dry grain transport located directly under the dryer discharge hopper. All tower dryer control panels include a starter to control this function. Simply hook up the power to the starter and the dry grain will start moving. The Dry Conveyor Starter aux is the "un-sensitise" for the dryer unload. Please use this starter.

If you wish to add plug switches to the Dry Conveyor, remove the yellow jumper wire between PLC- and JCS, and install a N.L. dry contacts, in series between HLT & JCS. Do not forget to select the DRY CONVEYOR and DRY PATH PLUG options from the DRYER SETUP screen of the operator interface if these devices are installed.

AUX DRY CONVEYOR:
 This device is used to stop the dry conveyor in the event of a power outage. It must be running before starting dry conveyor, we call this device AUX DRY CONVEYOR.

- You may purchase the optional light push buttons, & pilot light installed in the operator interface. If you do not have these, you can purchase them separately.
- If you have an existing starter system for the AUX Dry Conveyor function, connect the aux contact of your own device as shown in the draw to the right.
- Do not forget to select the AUX DRY CONVEYOR option from the DRYER SETUP screen of the operator interface after the AUX DRY CONVEYOR is installed.

note: located in control panel note located in power panel note located in power panel

DRY LEG:

- If an optional DRY LEG STARTER was not provided with your panel, connect your starter as shown in the left and center draws.
- If you have an existing DRY LEG STARTER with a separate control, you must provide either a N.O. aux contact from your starter or a leg monitor contact that closes when the leg is running OK. Connect the contact as shown in the draw to the right.
- Do not forget to select the DRY LEG option from the DRYER SETUP screen of the operator interface after the DRY LEG is installed.

note: located in control panel note located in power panel note located in power panel

TOP DRY CONVEYOR:
 If there is another conveyor after the Dry Leg, we call this device TOP DRY CONVEYOR.

- You may purchase the optional starter, push buttons, & pilot light installed in the dryer panel, which are connected as shown in the left and center draws.
- If you have an existing starter system for the Top Dry Conveyor function, connect aux contact of your device as shown in the draw to the right.
- Do not forget to select the TOP DRY CONVEYOR from the DRYER SETUP screen of the operator interface after the TOP DRY CONVEYOR is installed.

note: located in control panel note located in power panel note located in power panel

8. Tower Dryer - Domestic Wiring Diagrams

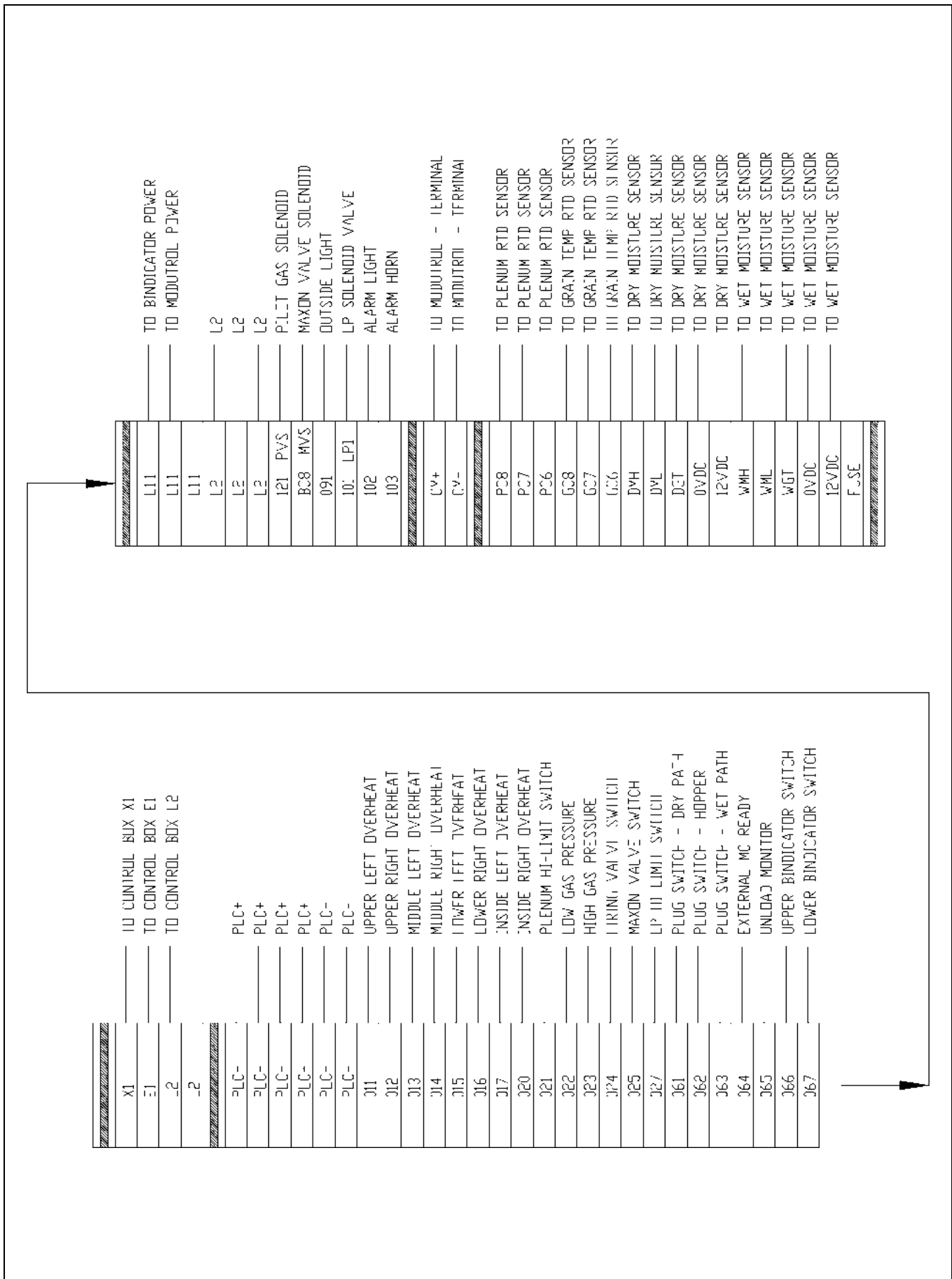

NOTES



Tower Dryer CSA 3-Fan Wiring Diagrams

9. Tower Dryer - CSA Wiring Diagrams

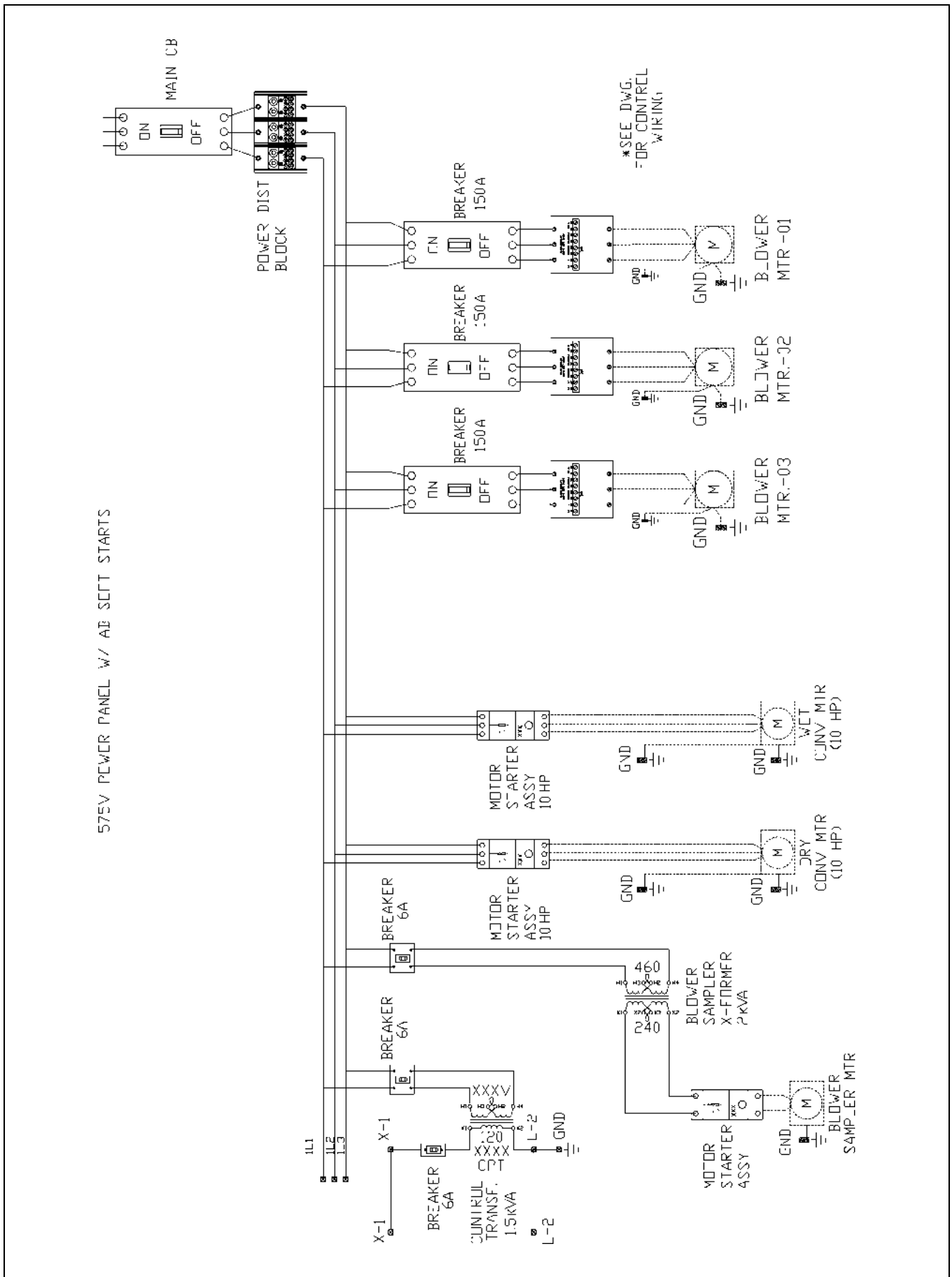

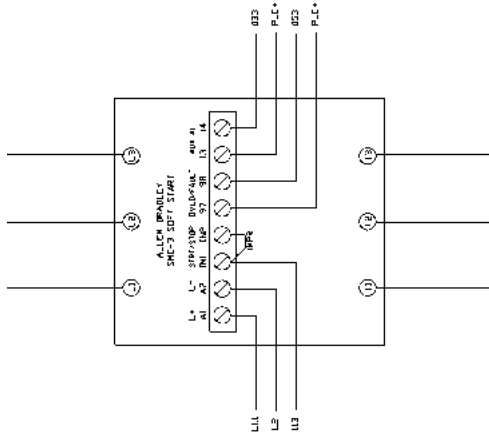

BLOWER #1

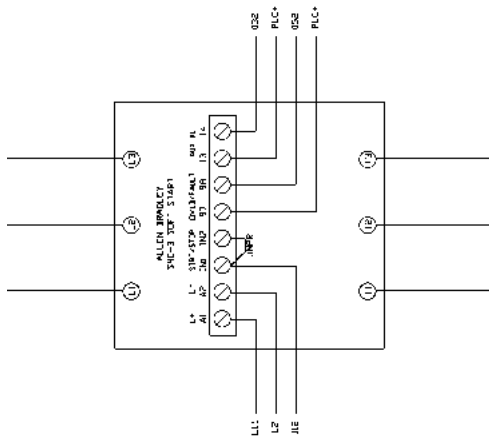

BLOWER #2

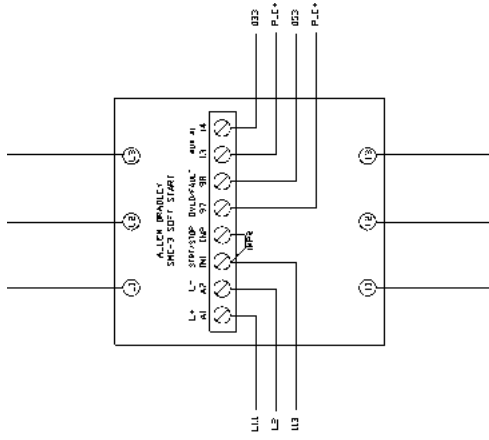

BLOWER #3

- 120VAC
- NEUTRAL
- EXTERNAL 24 VDC PS
- STARTER ACK TO PLC
- STARTER FAULT TO PLC
- P.C BLOWER #1 START RELAY
- P.C BLOWER #1 START RELAY

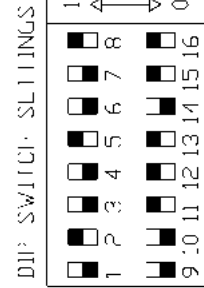

9. Tower Dryer - CSA Wiring Diagrams

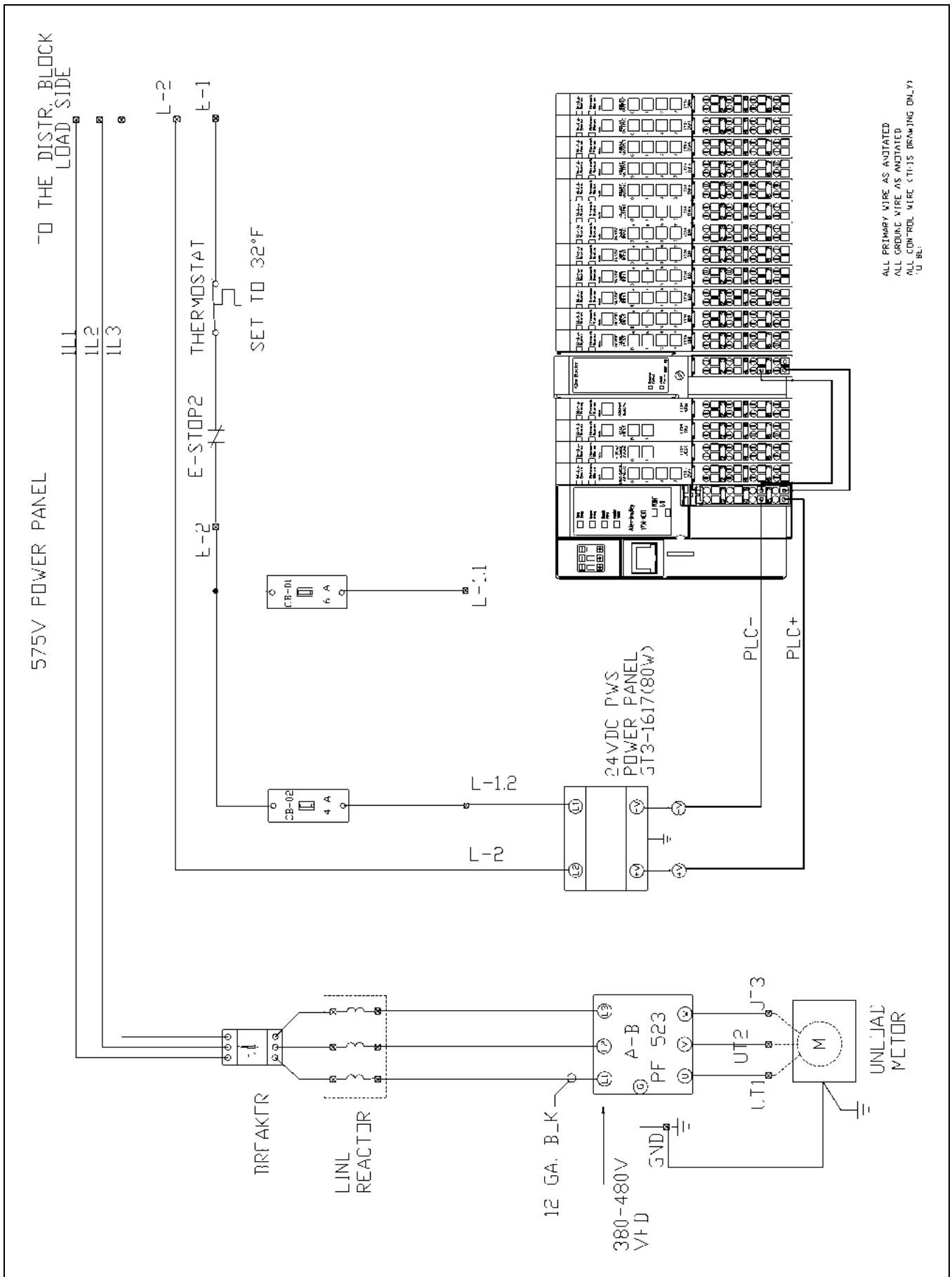

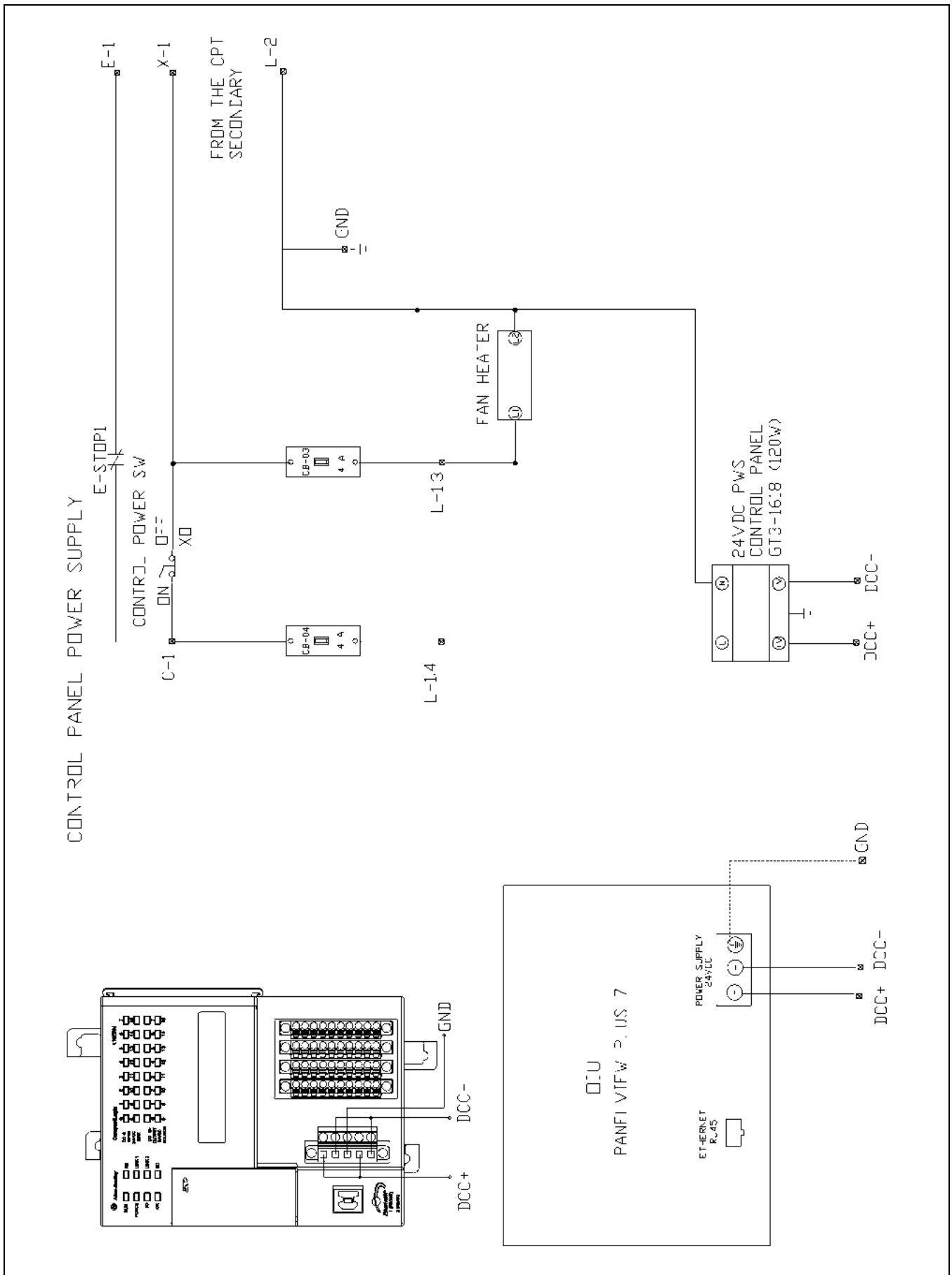

9. Tower Dryer - CSA Wiring Diagrams

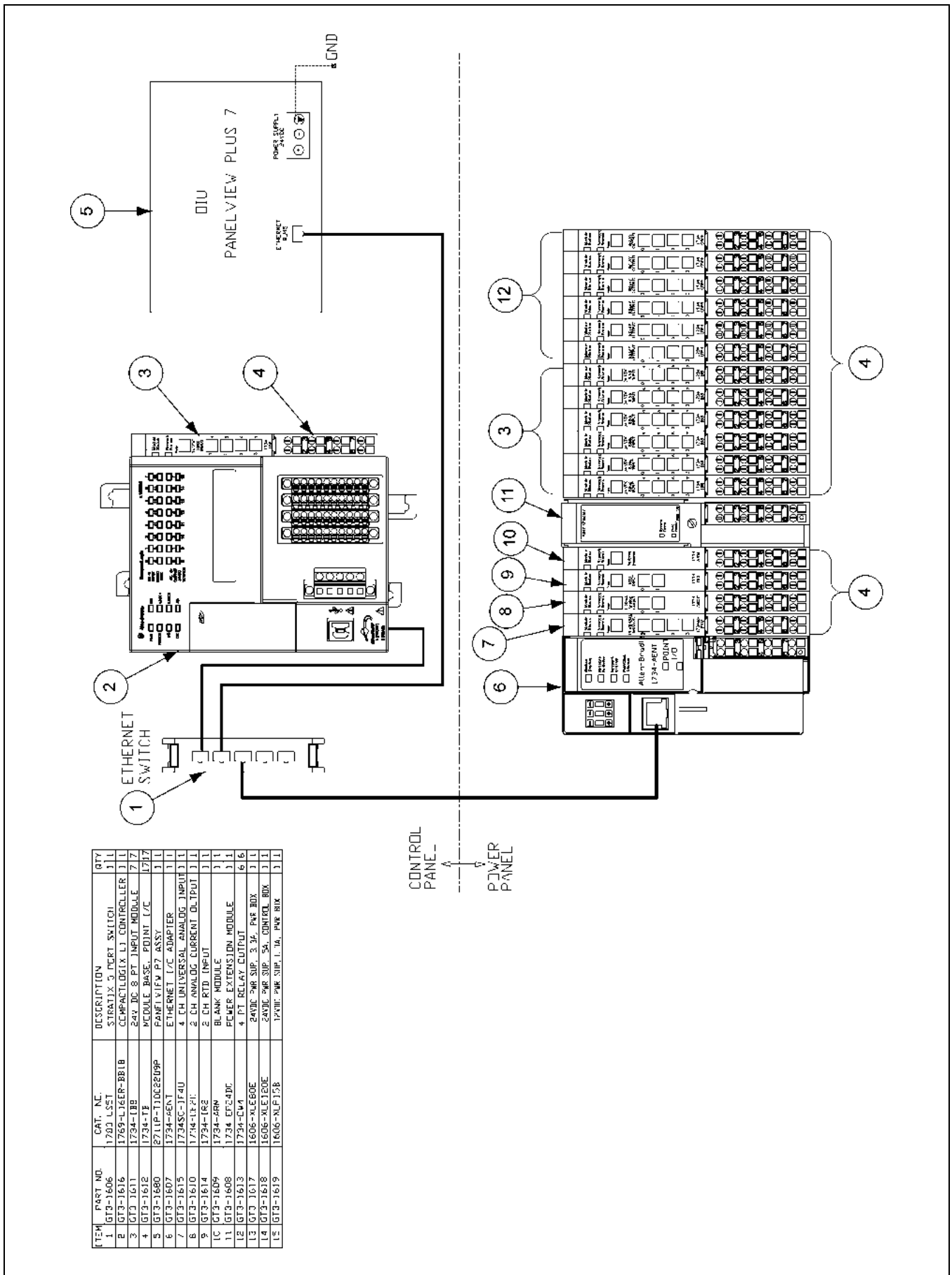

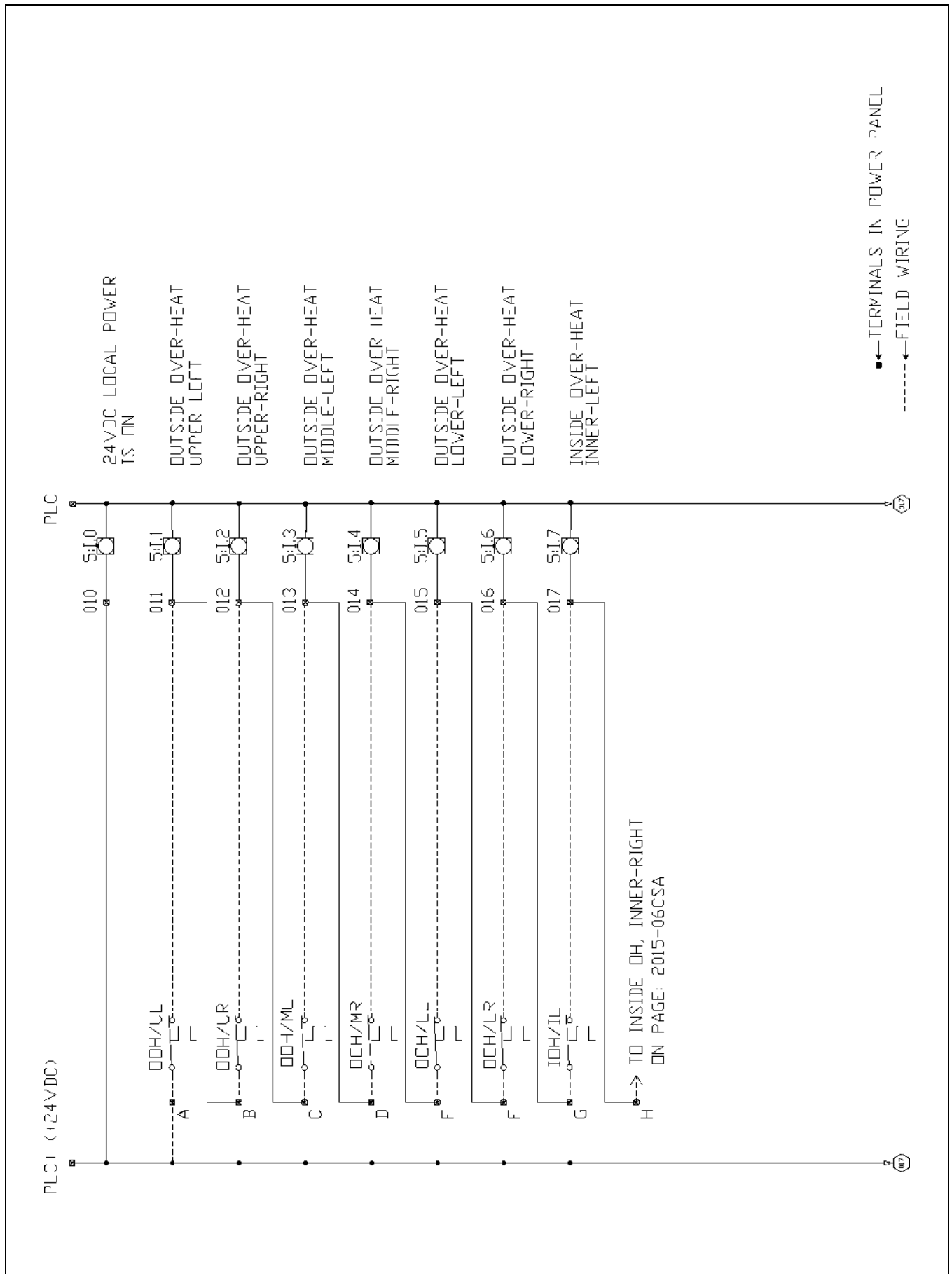

9. Tower Dryer - CSA Wiring Diagrams

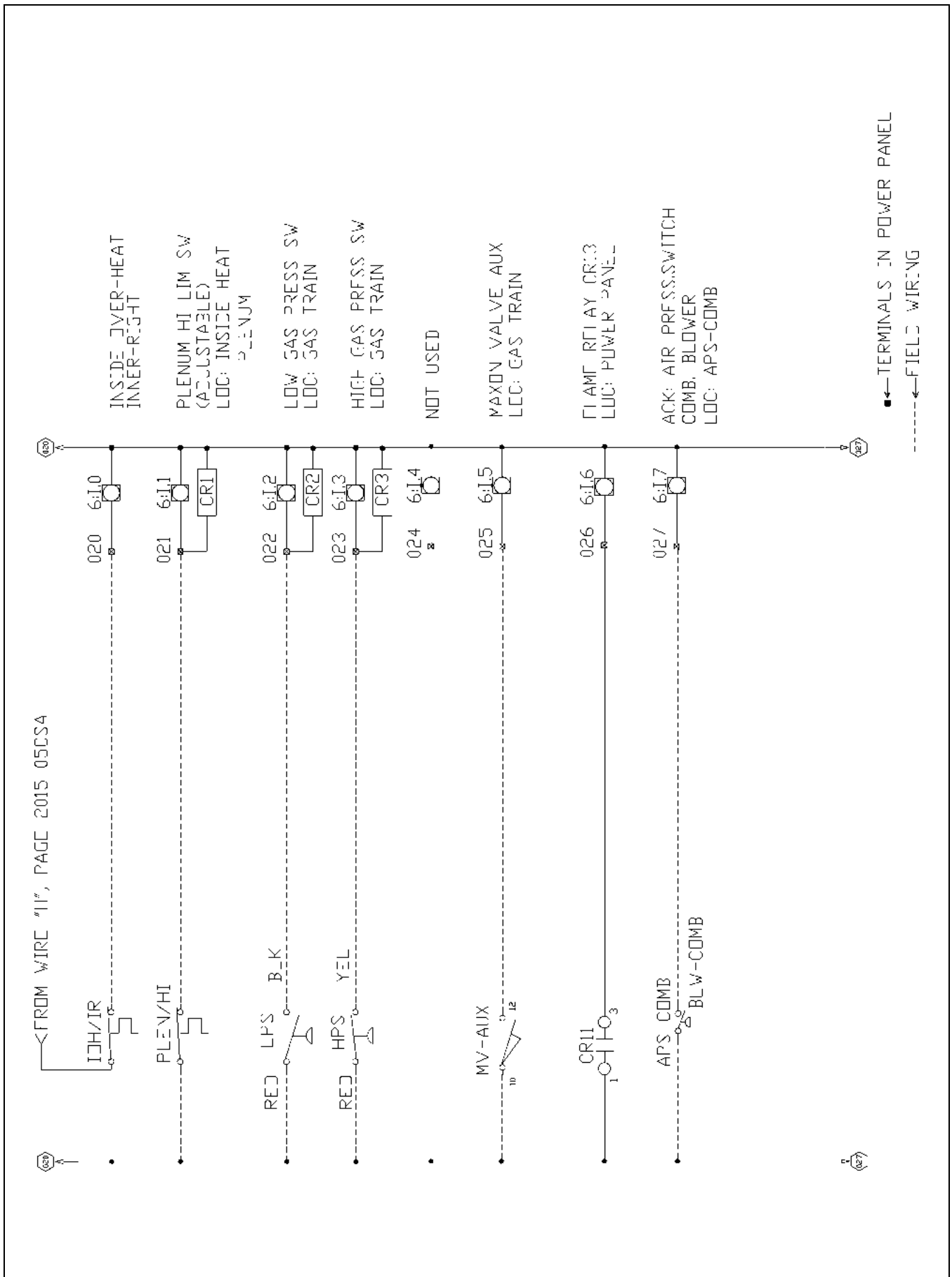

9. Tower Dryer - CSA Wiring Diagrams

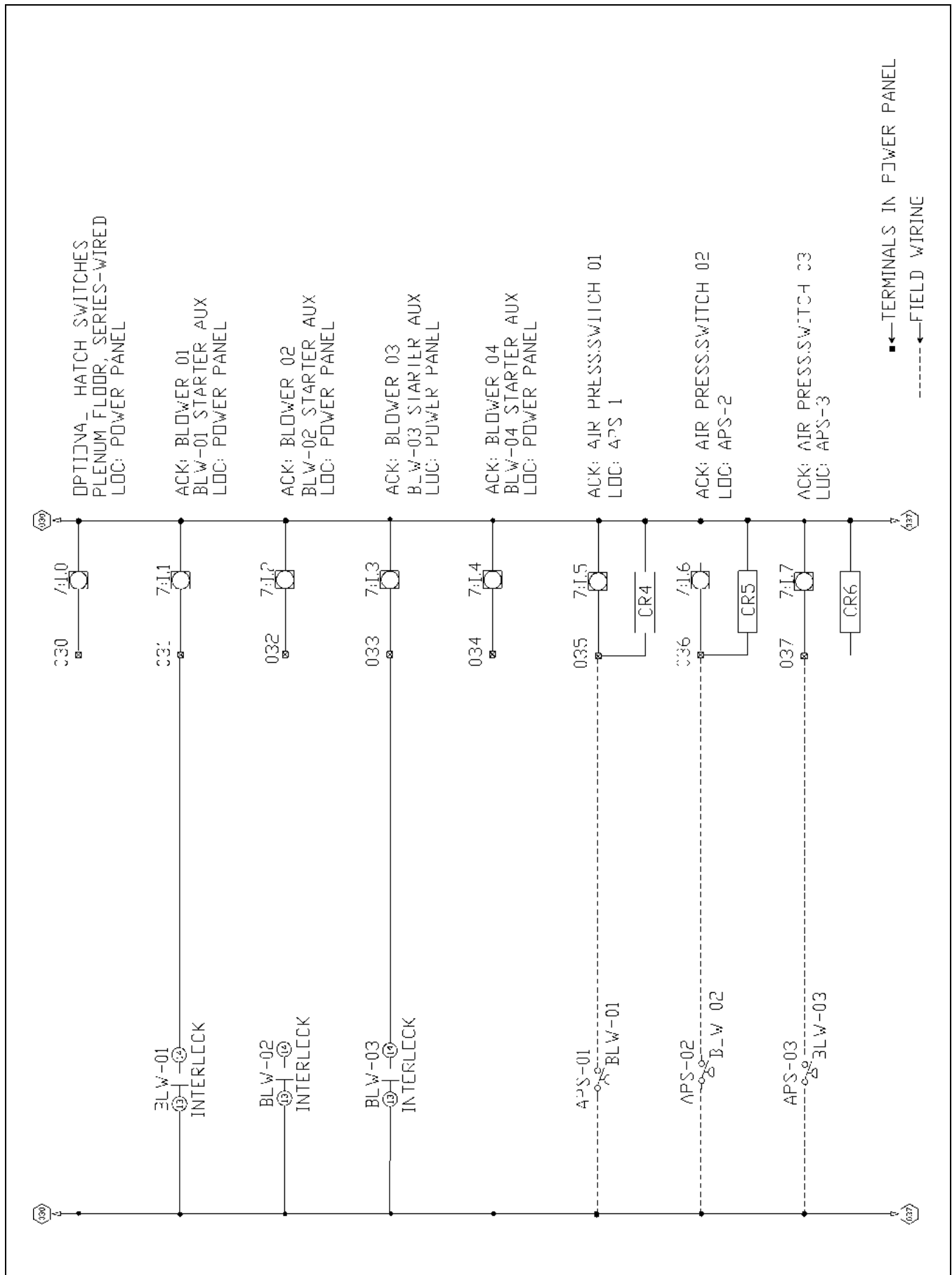

9. Tower Dryer - CSA Wiring Diagrams

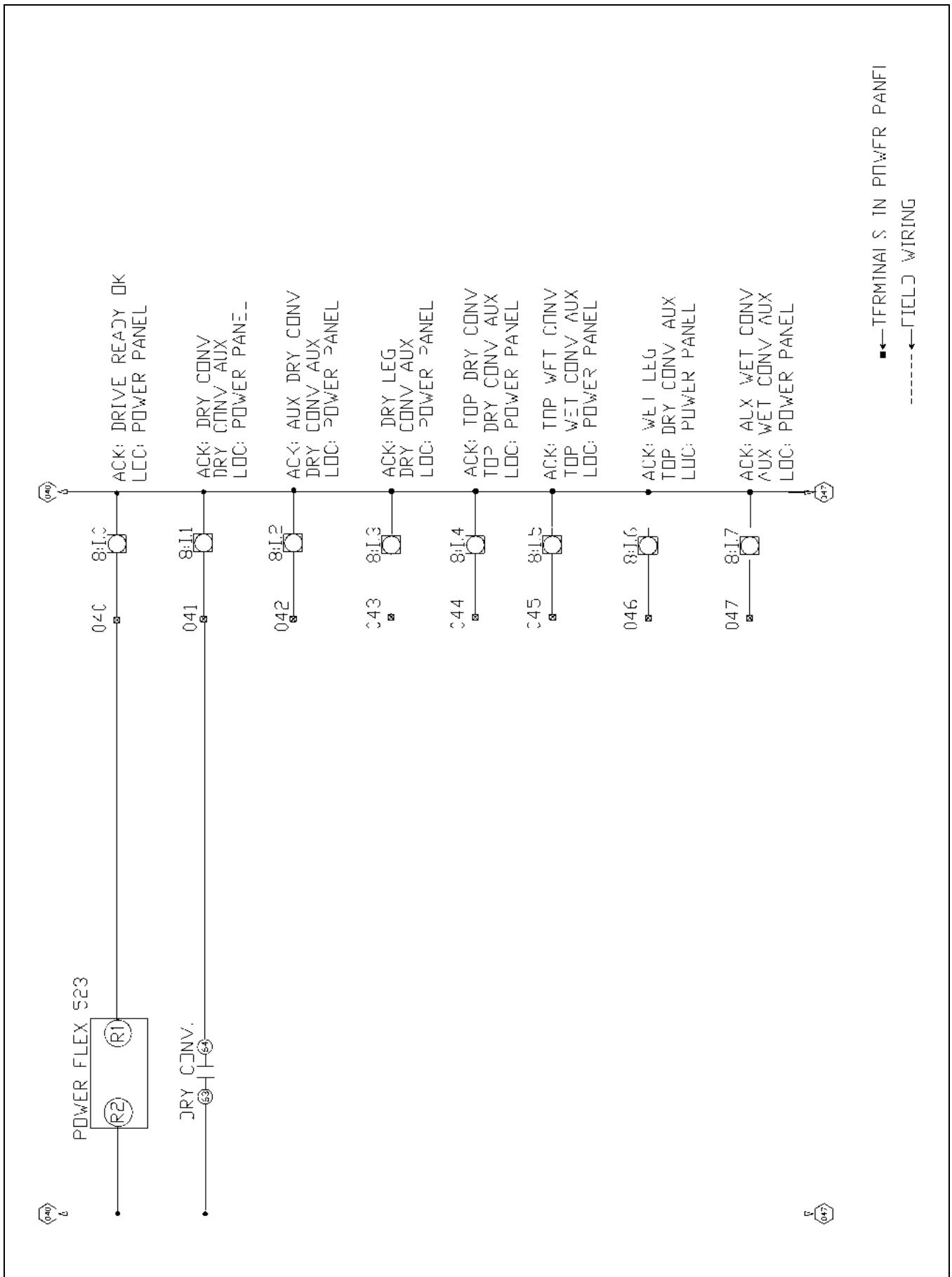

9. Tower Dryer - CSA Wiring Diagrams

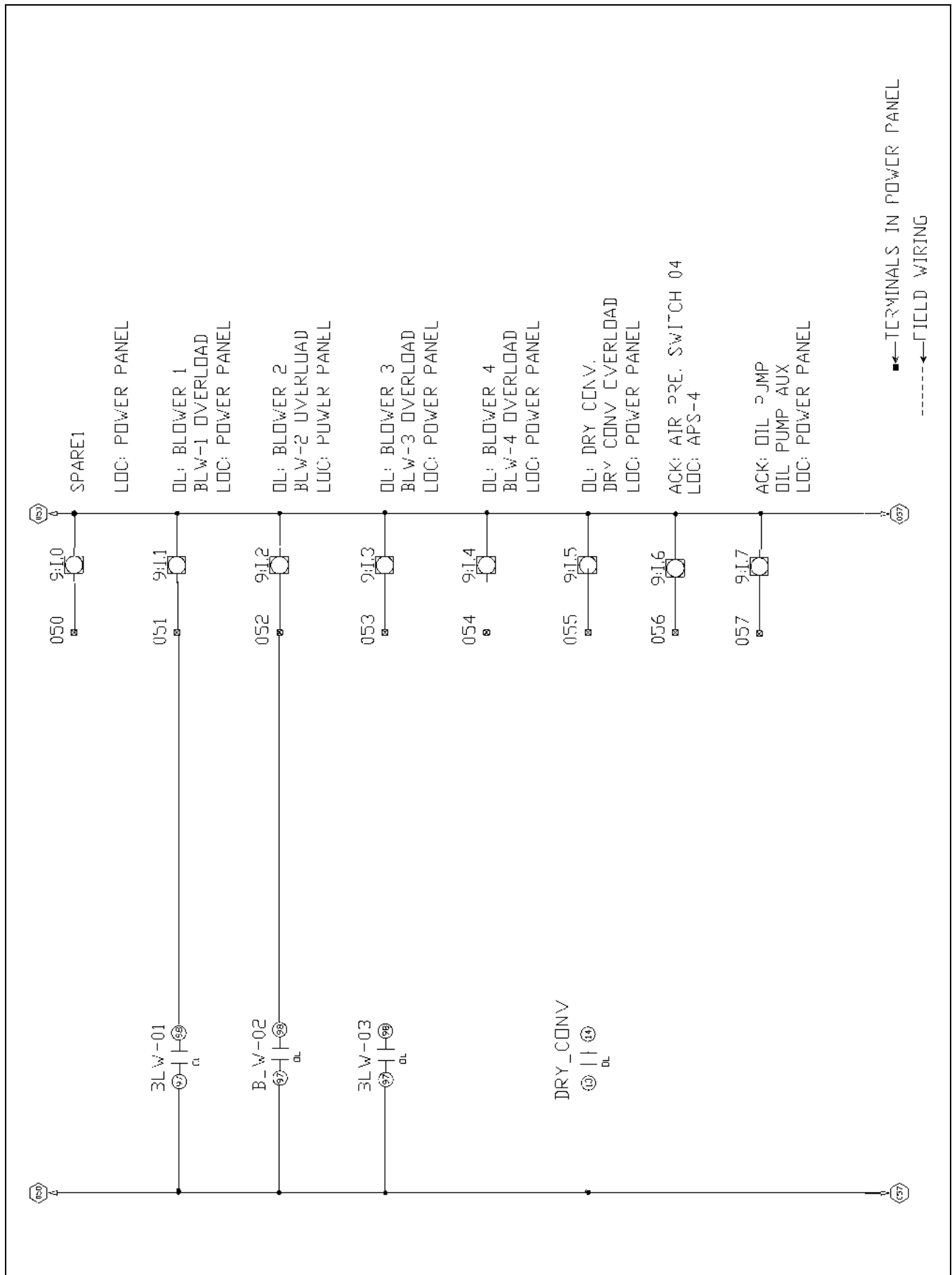

9. Tower Dryer - CSA Wiring Diagrams

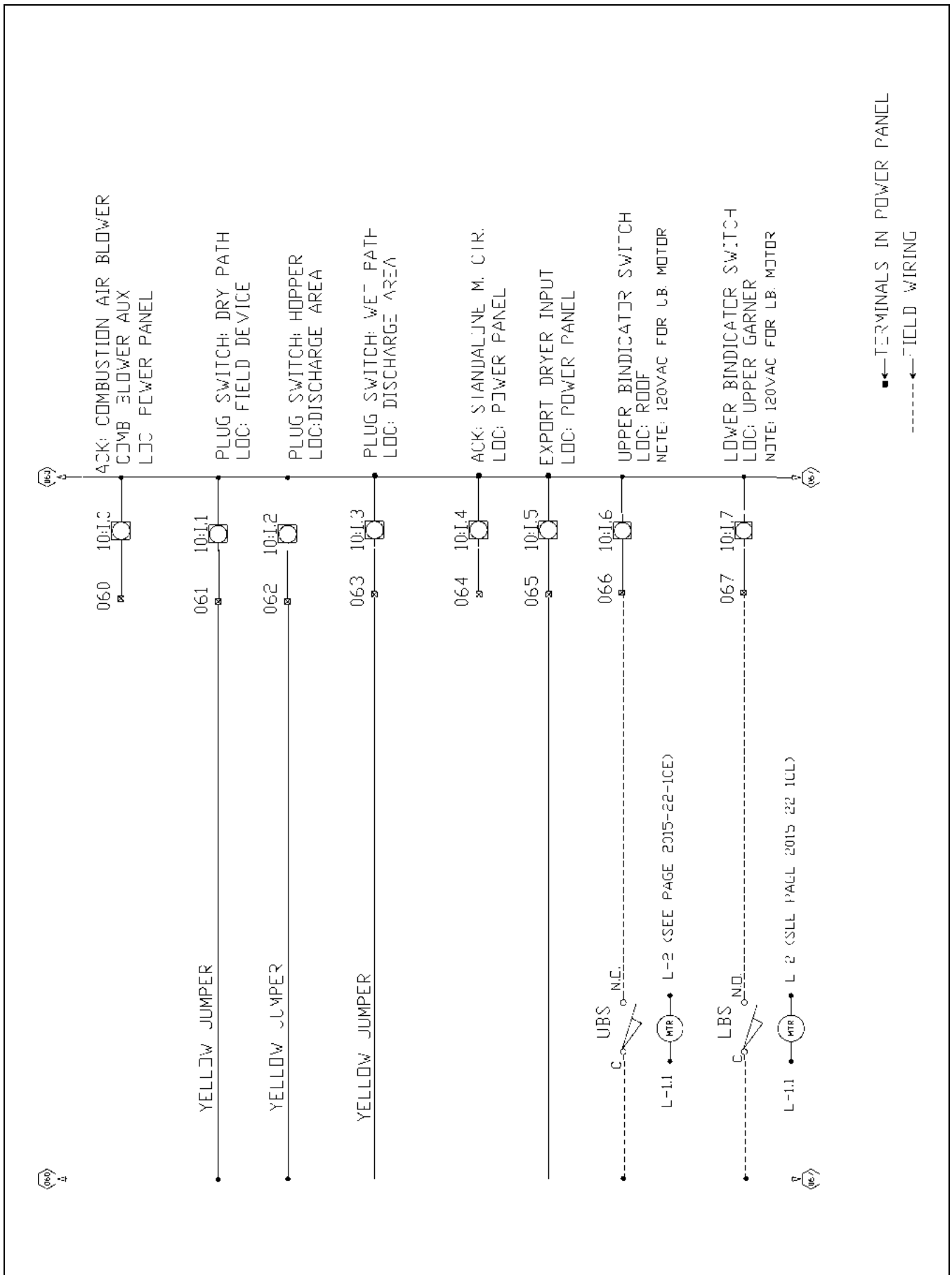

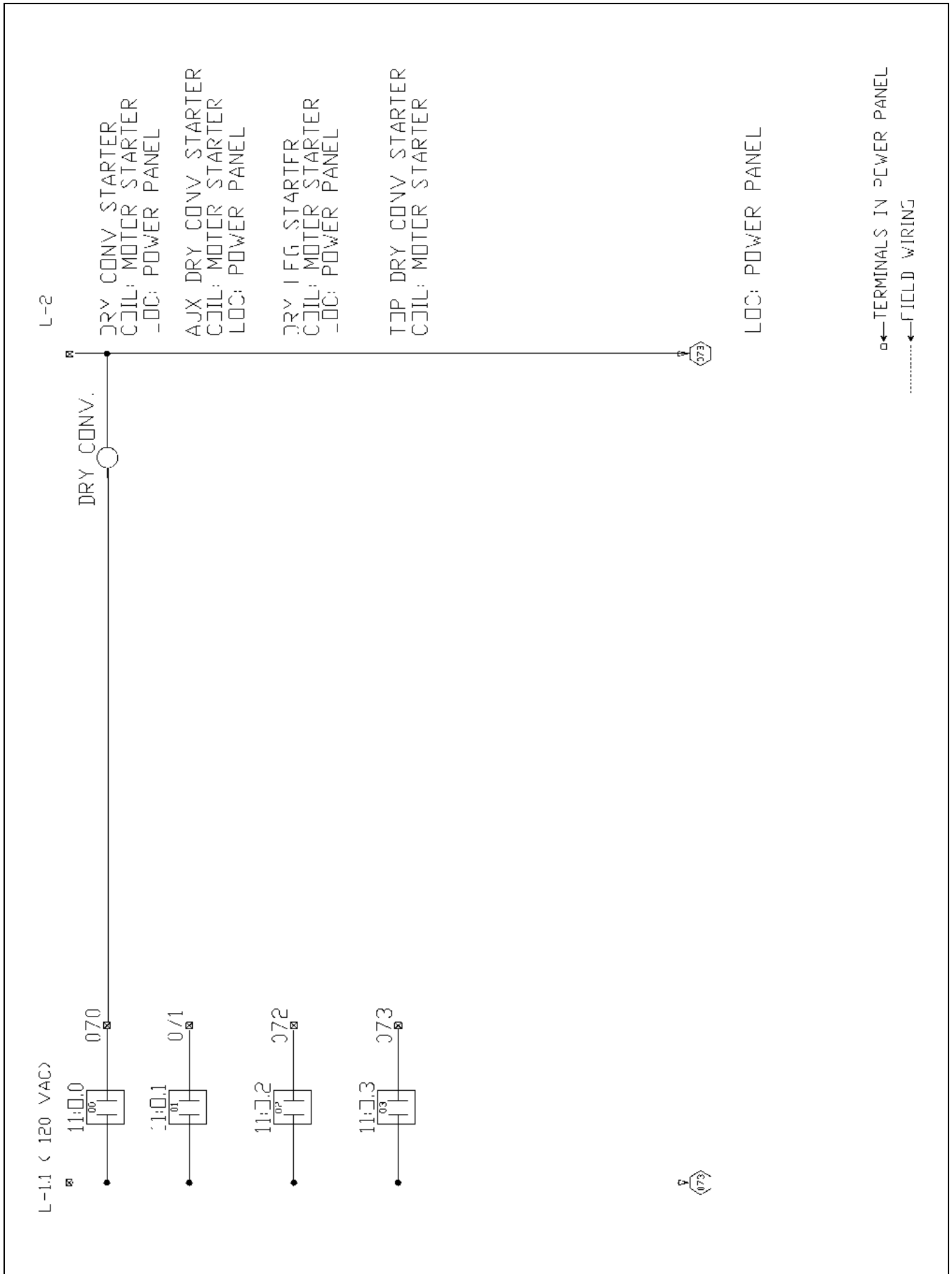

9. Tower Dryer - CSA Wiring Diagrams

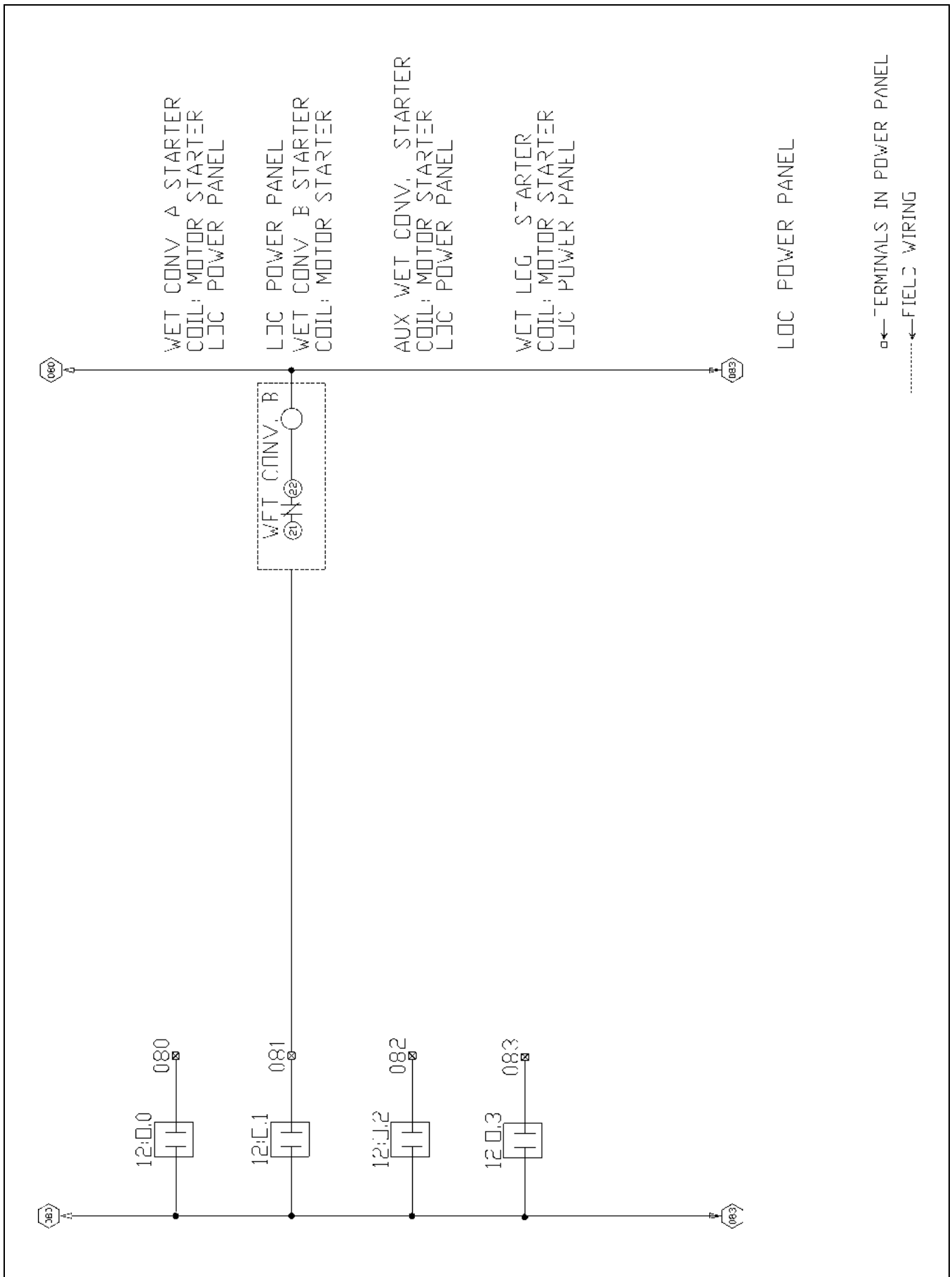

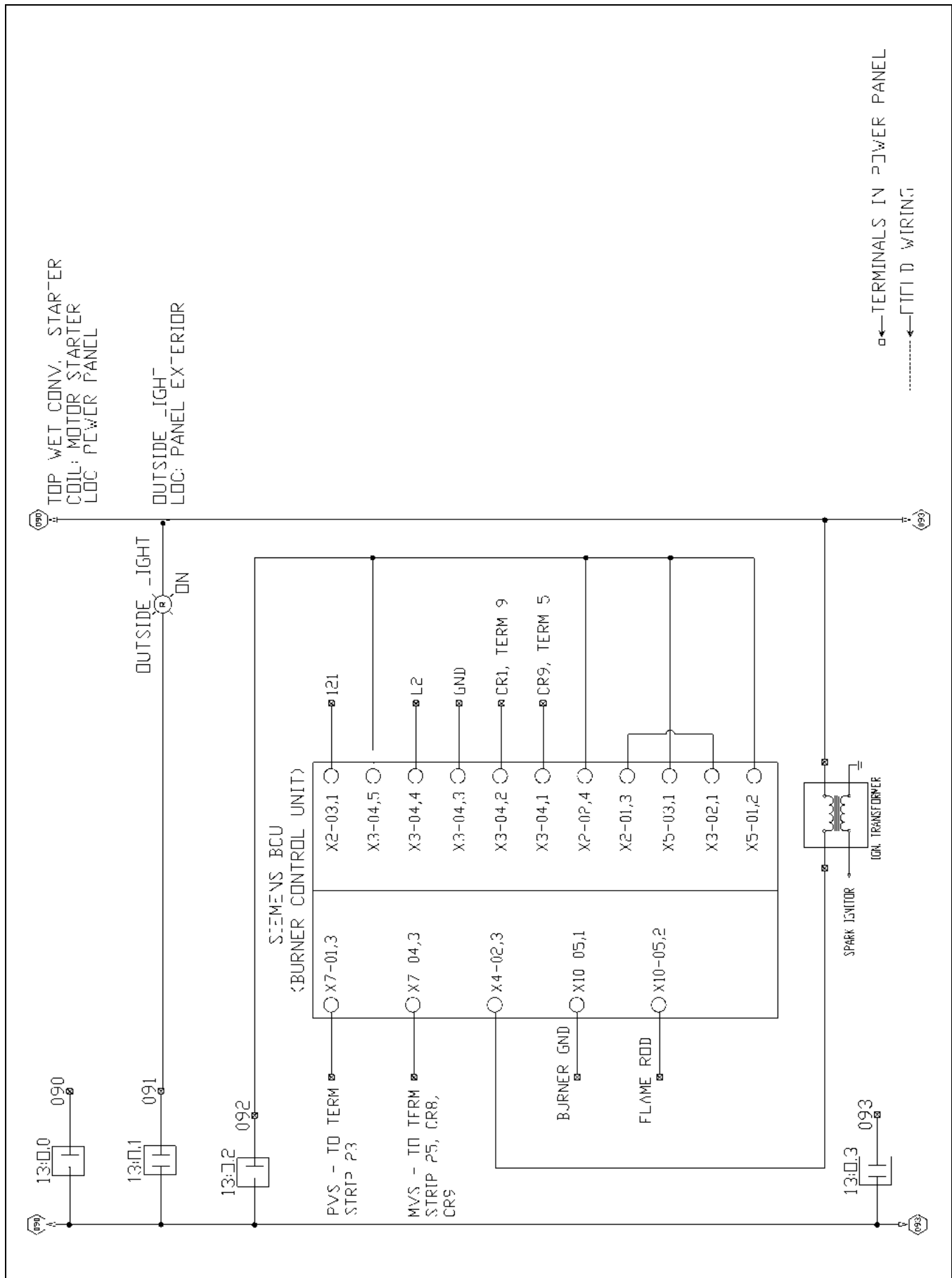

9. Tower Dryer - CSA Wiring Diagrams

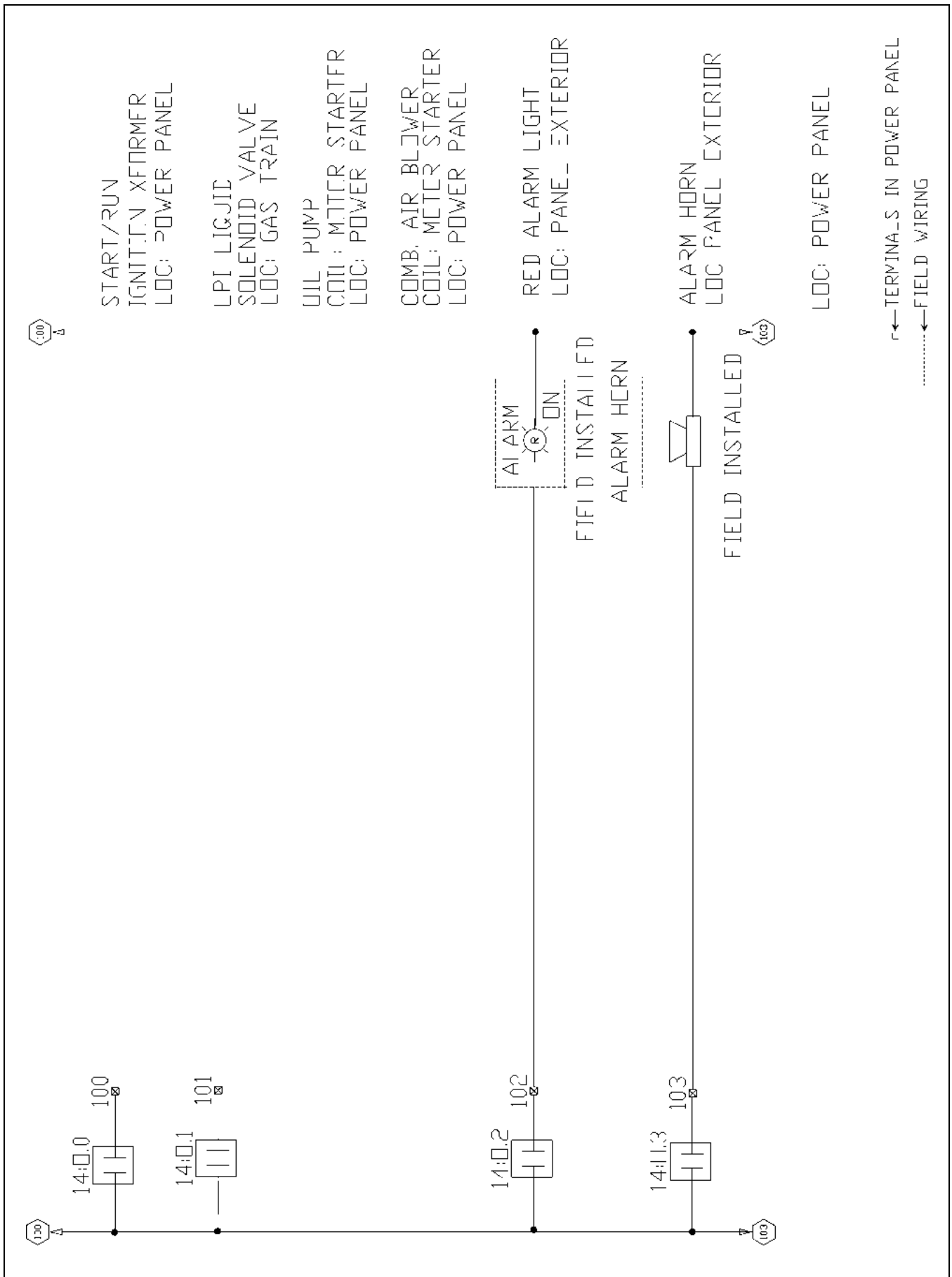

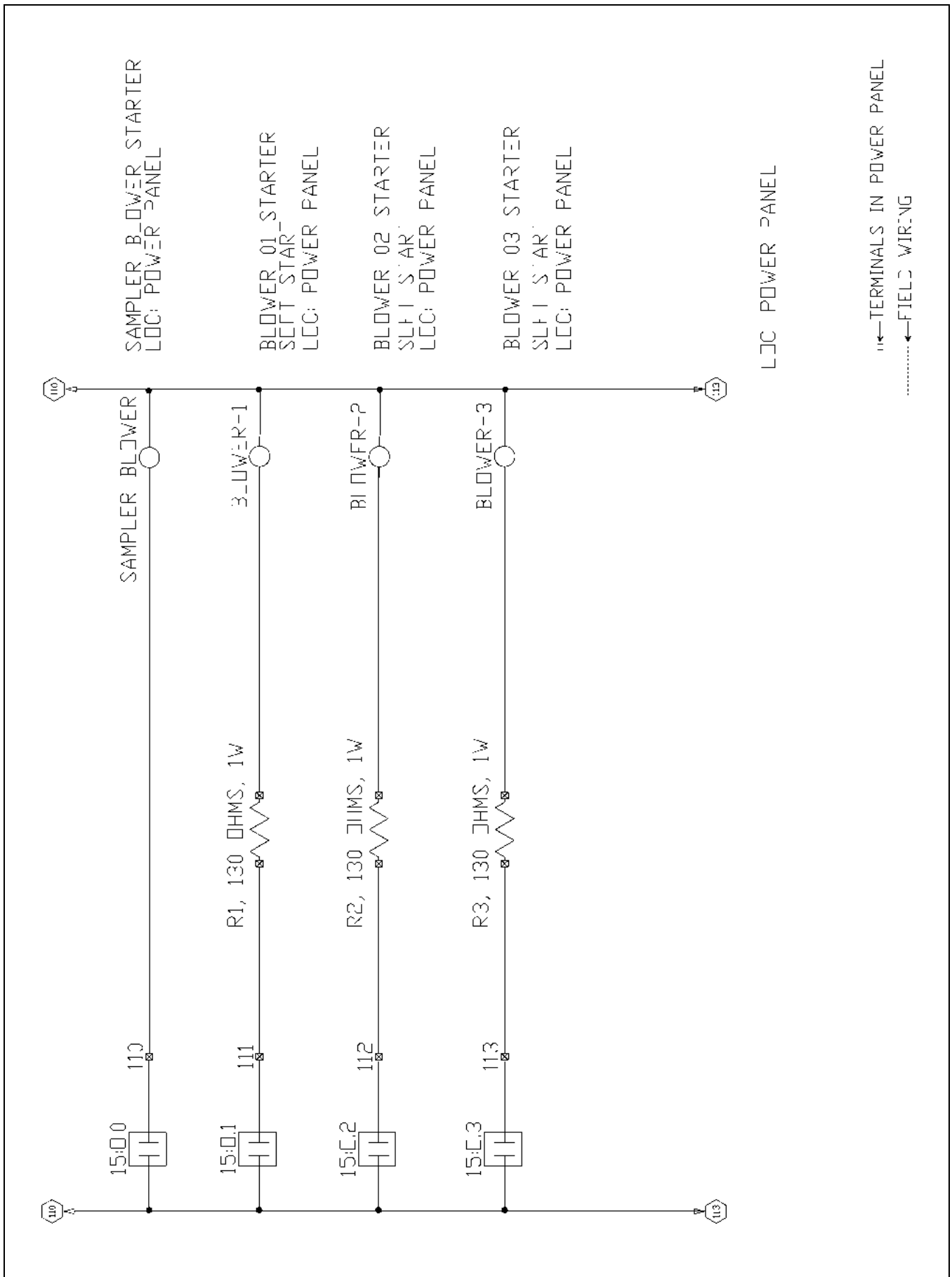

9. Tower Dryer - CSA Wiring Diagrams

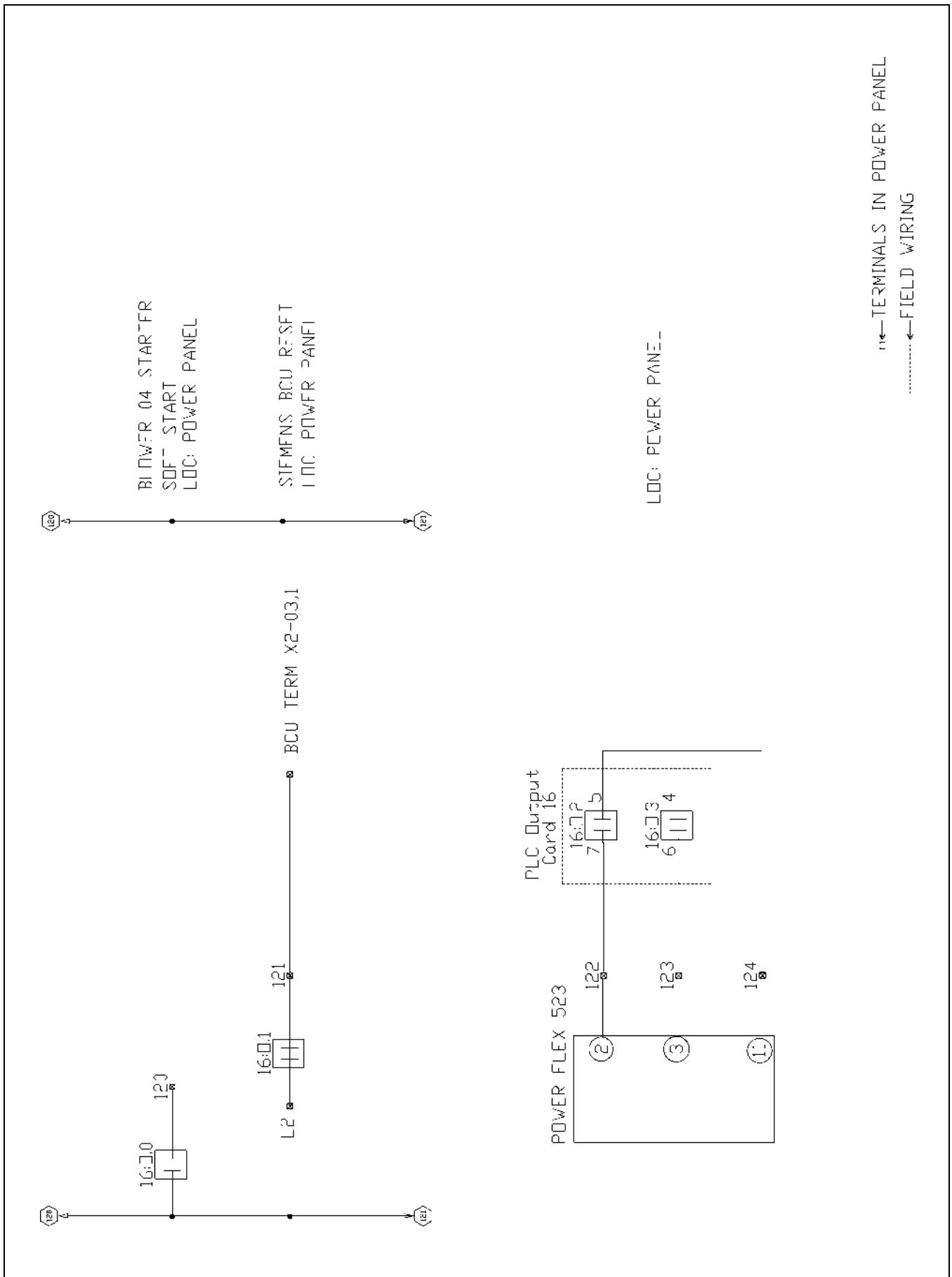

9. Tower Dryer - CSA Wiring Diagrams

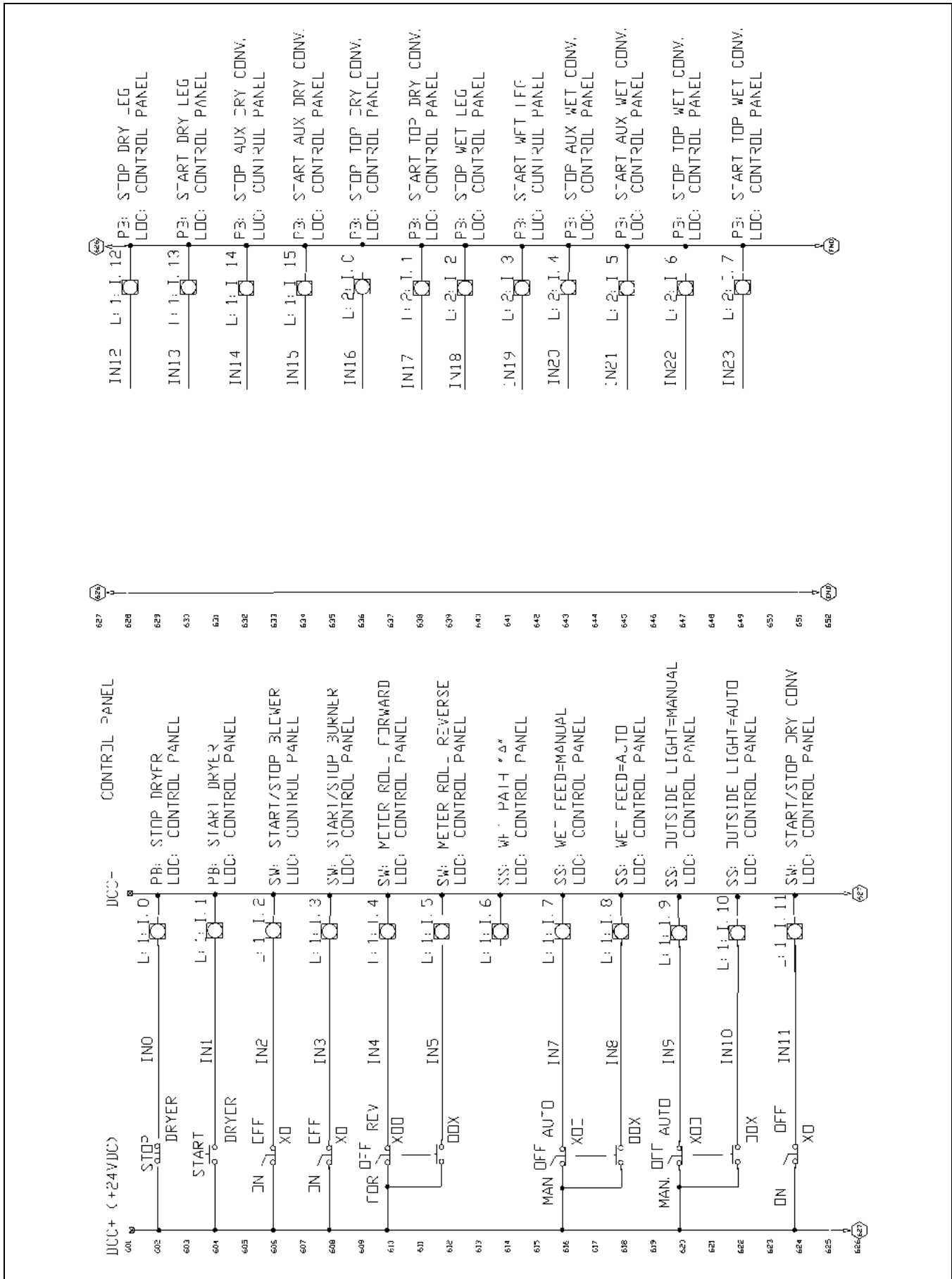

9. Tower Dryer - CSA Wiring Diagrams

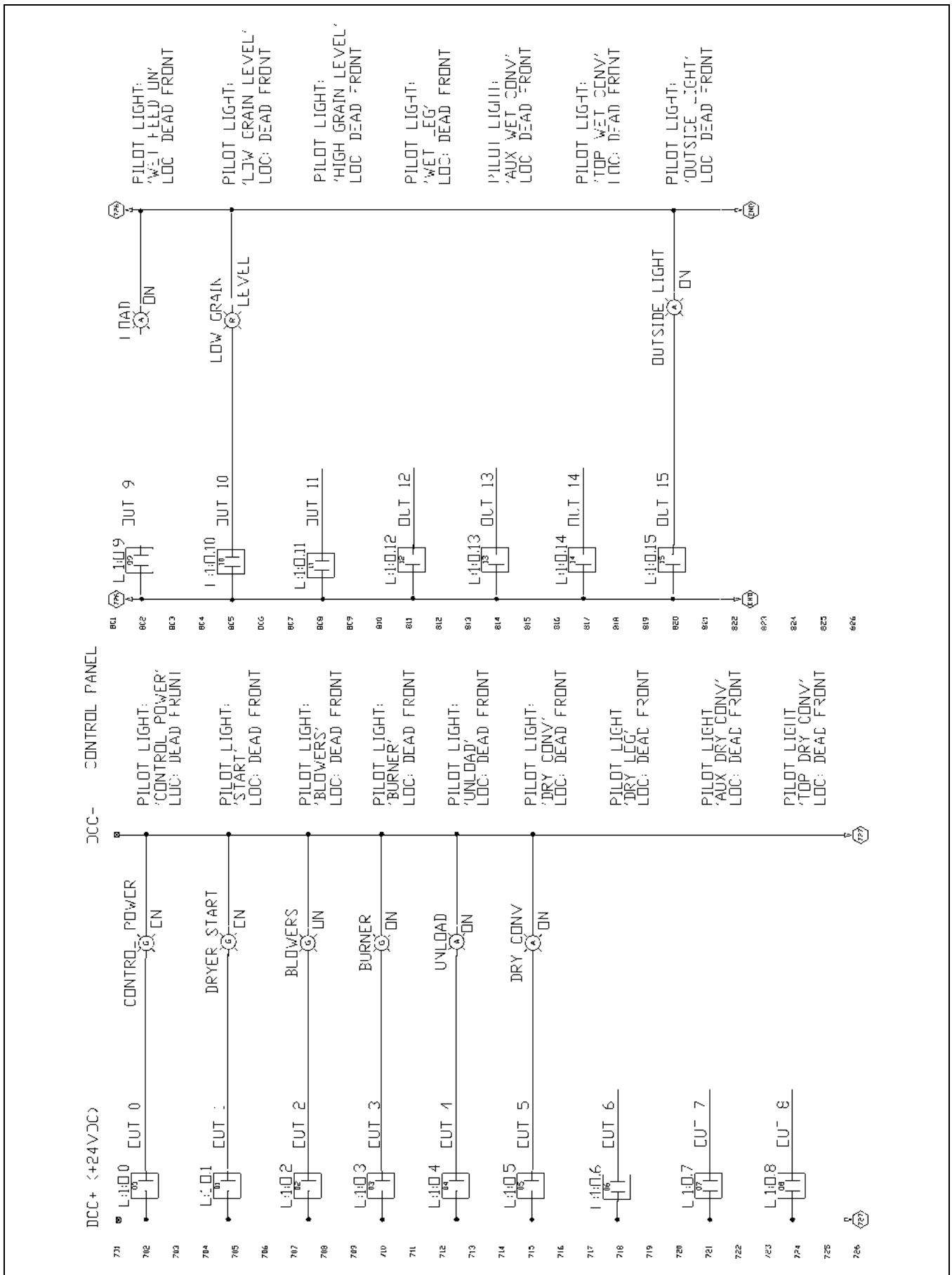

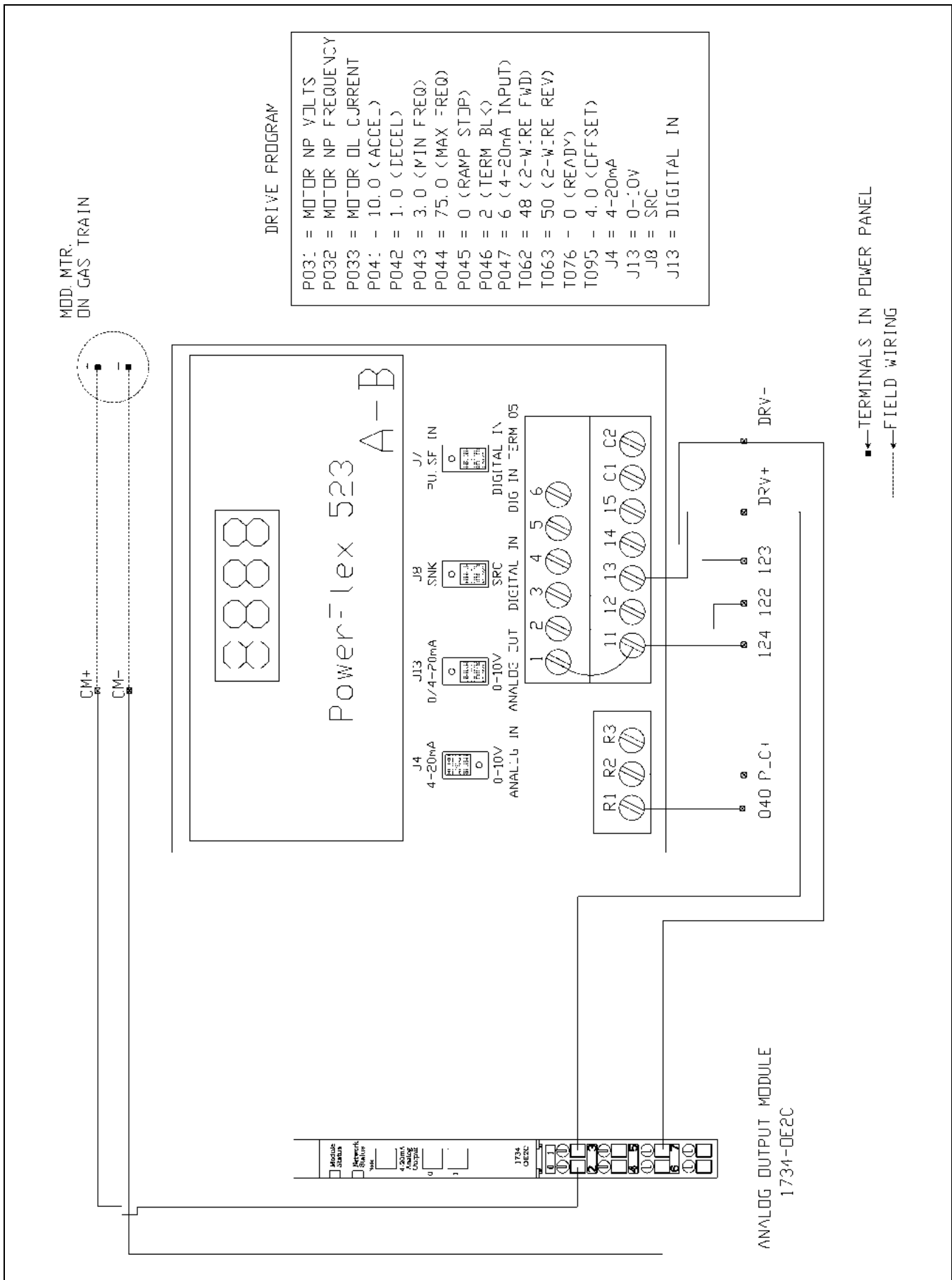

9. Tower Dryer - CSA Wiring Diagrams

* MOUNT THE WET SENSOR ON THE SIDE WALL OF THE GARNER BIN, 1FT BELOW THE LOWER BINDICATOR

POWER SUPPLY
FOR JMC SENSOR
+12VDC

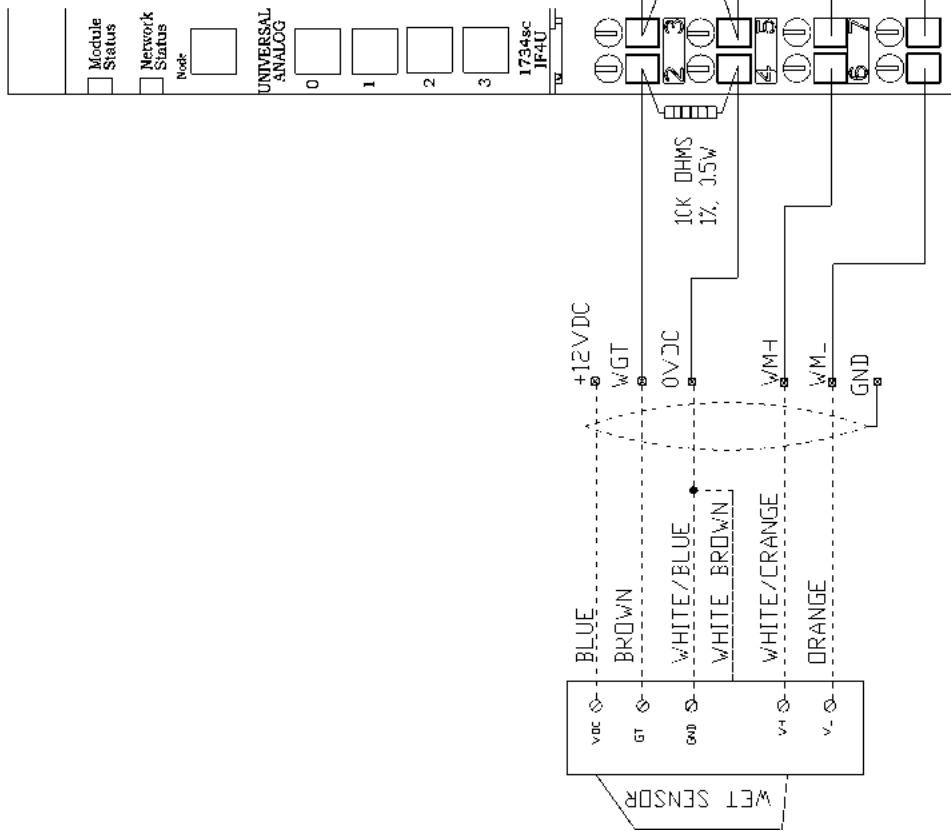
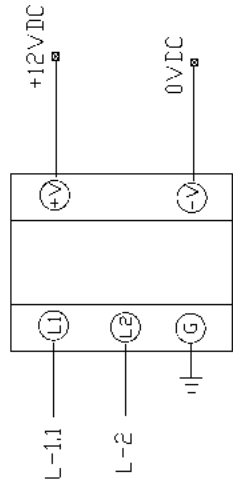

— TERMINALS IN POWER PANEL
- - - FIELD WIRING

1734sc-IF4U
Universal Input

** MOUNT THE GRAIN RTD 3FT ABOVE THE END OF THE DRYING SECTION

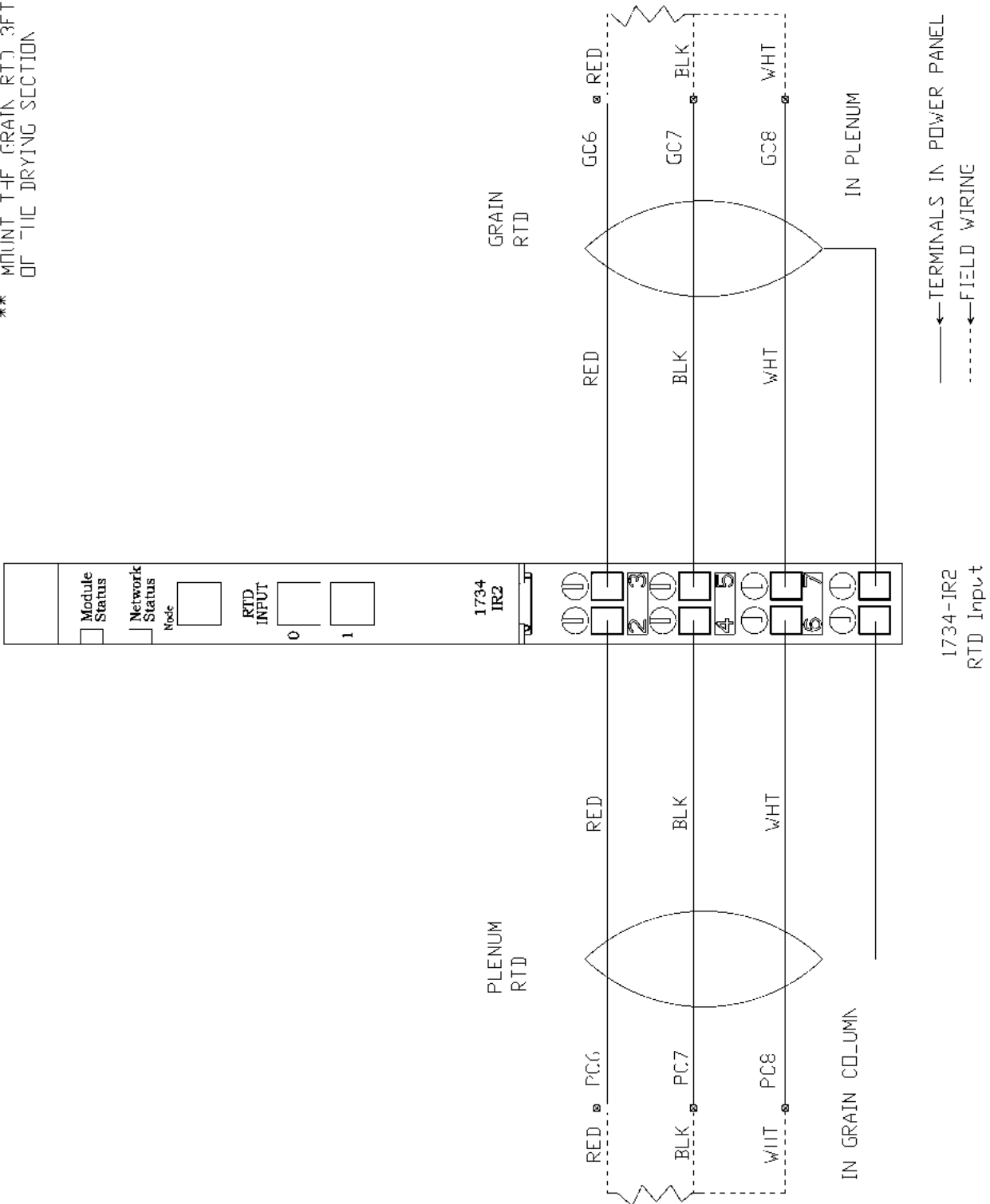

9. Tower Dryer - CSA Wiring Diagrams

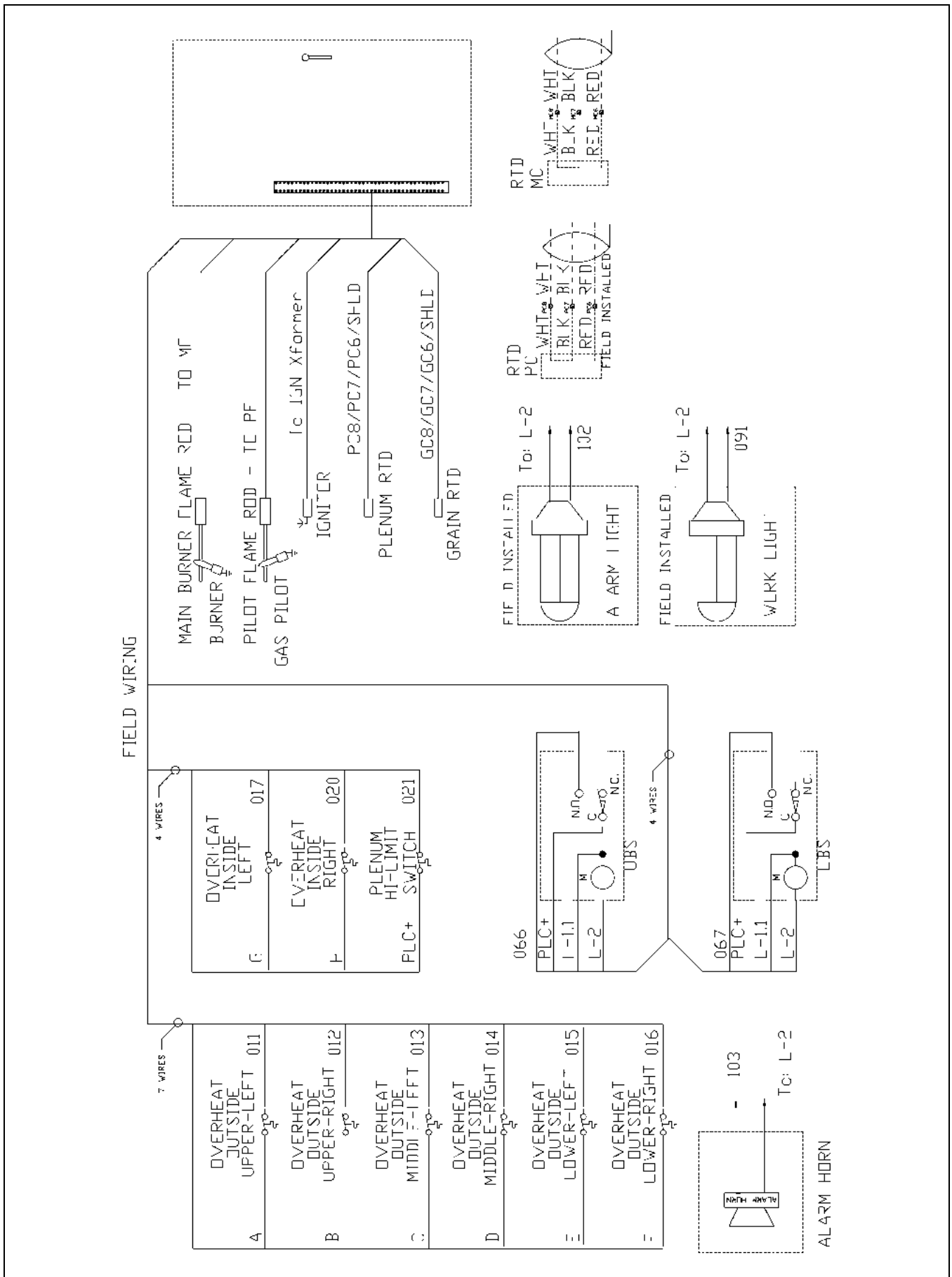

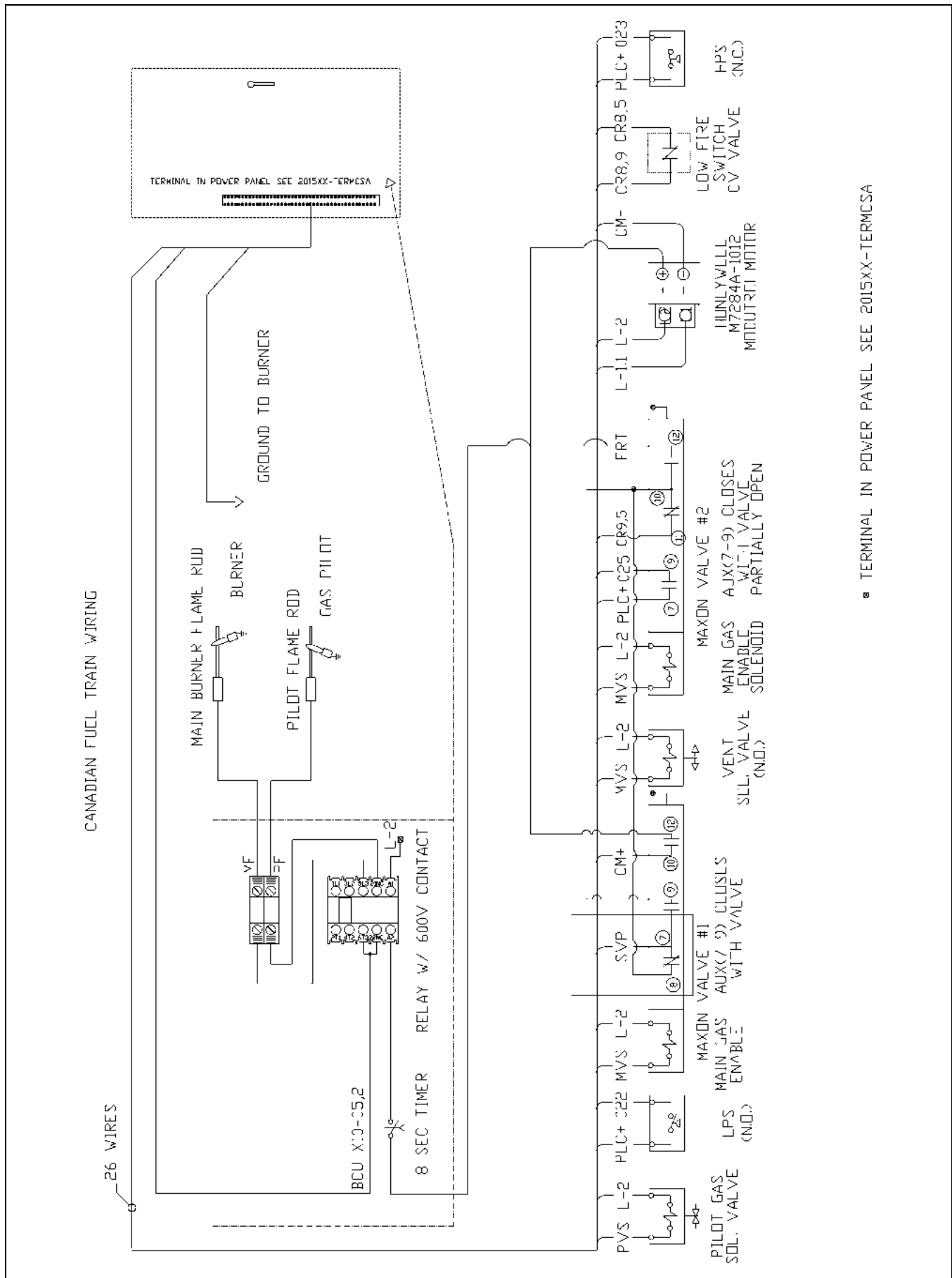

9. Tower Dryer - CSA Wiring Diagrams

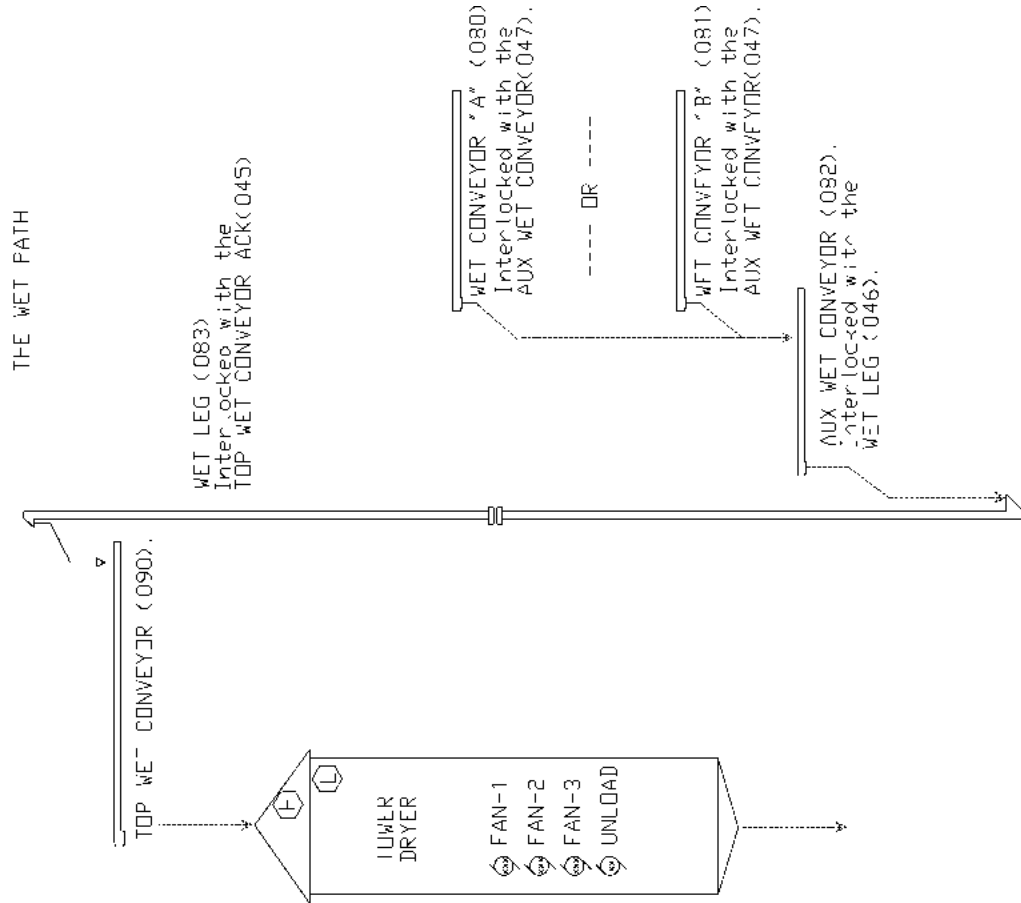
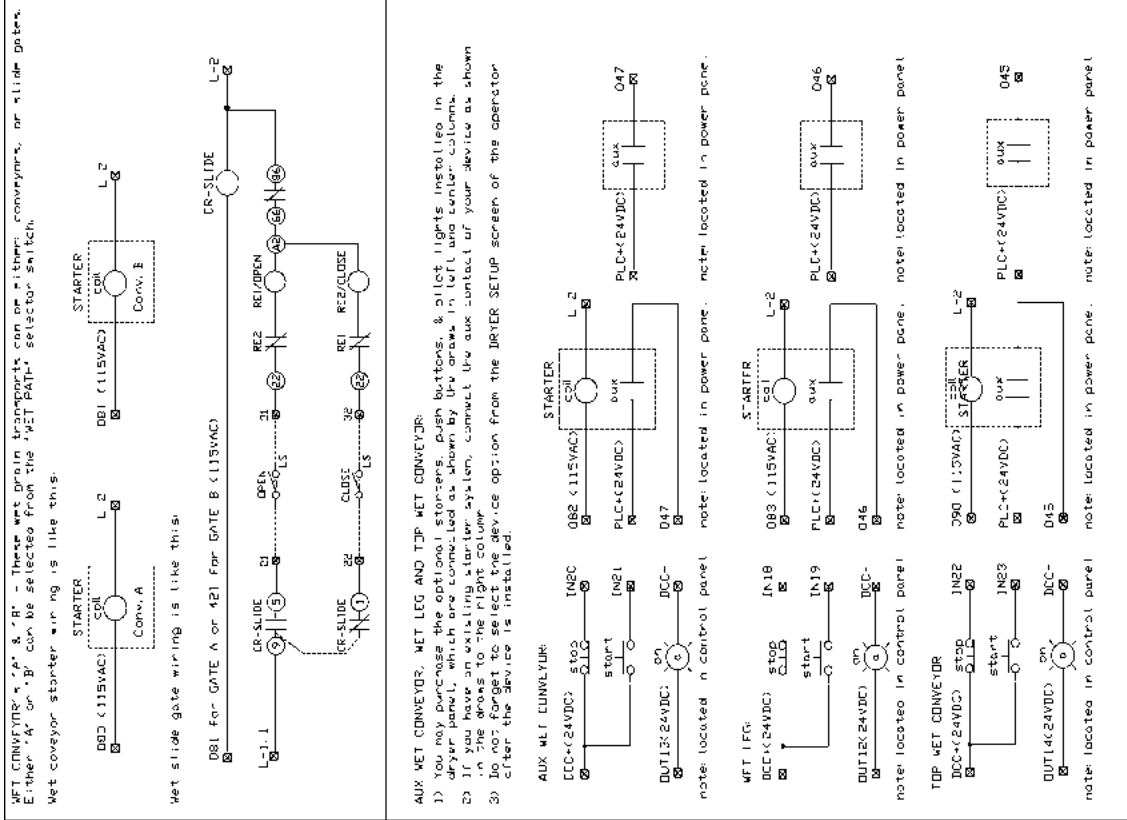

THE DRY PATH

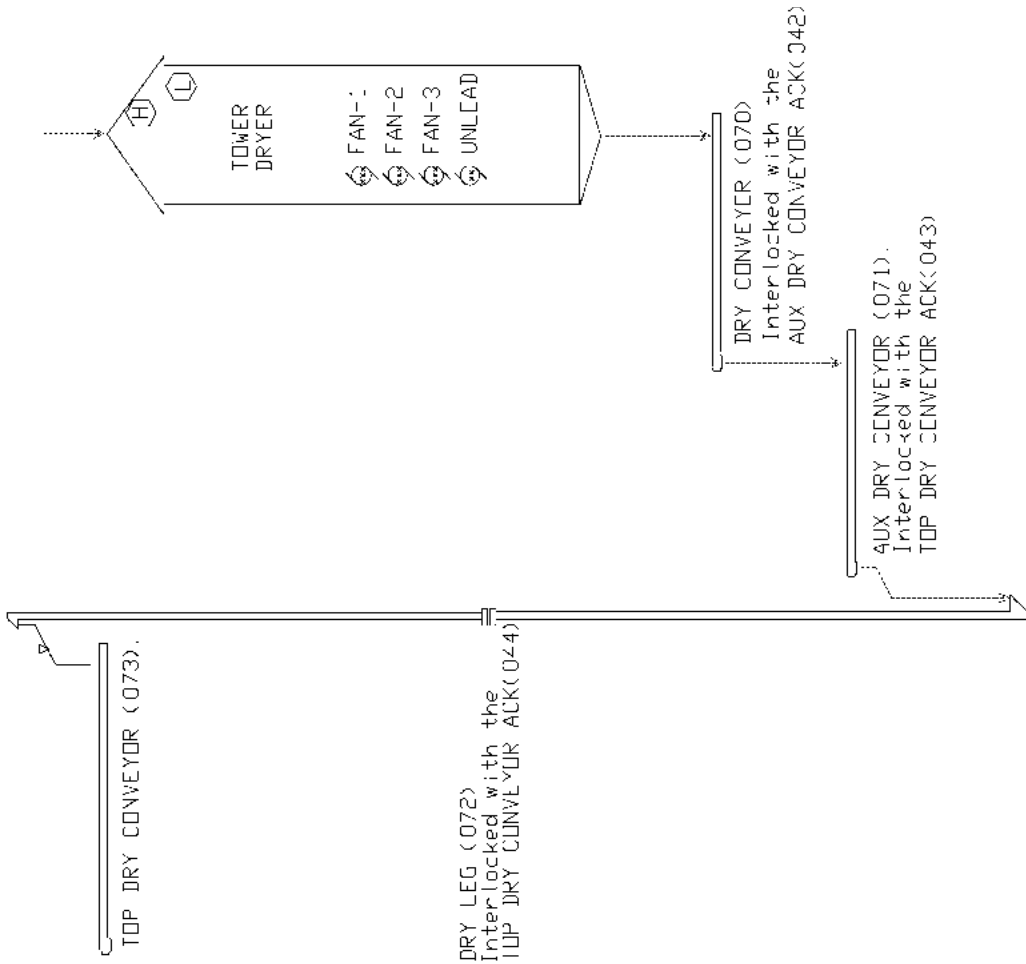

DRY CONVEYOR:
 To be used with the Dry Path, a transparent located directly under the dryer discharge hopper. A 1/2" Tower Dryer control panel is included to control this function. A 1/2" Dry Hook up the motor. It leads to the starter and check rotation. The included Dry Conveyor Starter aux is the run-permissive for the dryer unload. Please use the S starter!
 If you wish to add plug switches to the Dry Conveyor, remove the yellow jumper wire between 21C and 21B, and install a N.C. dry contacts, in case between 21C & 21B.
 Do not forget to select the DRY CONVEYOR and DRY PATH PLC options from the DRYER SETUP screen of the operator interface if those device are installed.

AUX DRY CONVEYOR:
 If the Dry Conveyor dumps into another conveyor (in addition to the DRY LEG), that must be running before starting Dry Conveyor, we call this device AUX DRY CONVEYOR.
 1) You may purchase the optional starter, push buttons, & Pilot Light installed in the dryer panel, which are connected as shown in the left and center draws.
 2) If you have an existing starter system for the AUX Dry Conveyor function, connect the aux contact of your device as shown in the draw to the right.
 3) Do not forget to select the AUX DRY CONVEYOR option from the DRYER SETUP screen of the operator interface after the AUX DRY CONVEYOR is installed.

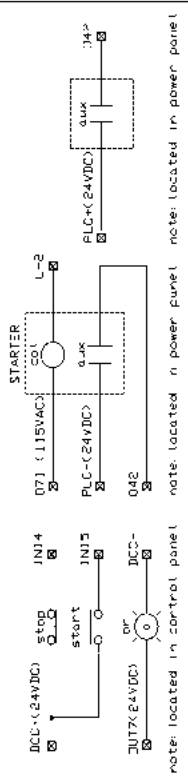

DRY LEG:
 1) If an optional DRY LEG STARTER was not provided with your panel, connect your starter as shown in the left and center draws.
 2) If you have an existing DRY LEG STARTER with a separate control, you must provide the aux contact of your device as shown in the draw to the right.
 3) Do not forget to select the DRY LEG option from the DRYER SETUP screen of the operator interface after the DRY LEG is installed.

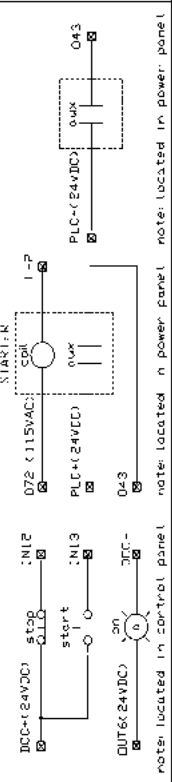

TOP DRY CONVEYOR:
 If there is another conveyor after the Dry Leg, we call this device TOP DRY CONVEYOR.
 1) You may purchase the optional starter, push buttons, & Pilot Light installed in the Dryer panel, which are connected as shown in the left and center draws.
 2) If you have an existing starter system for the Top Dry Conveyor function, connect the aux contact of your device as shown in the draw to the right.
 3) Do not forget to select the TOP DRY CONVEYOR option from the DRYER SETUP screen of the operator interface after the TOP DRY CONVEYOR is installed.

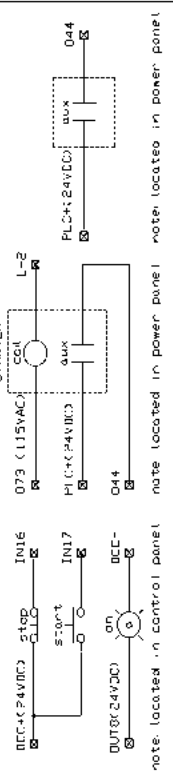

FIRE RELAY AND FLAME ACK RELAY

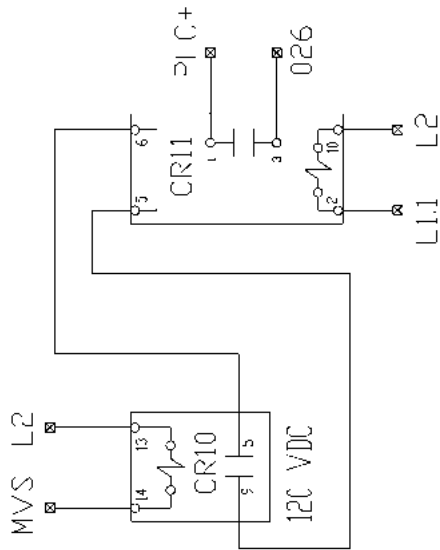

CR11 SETTINGS

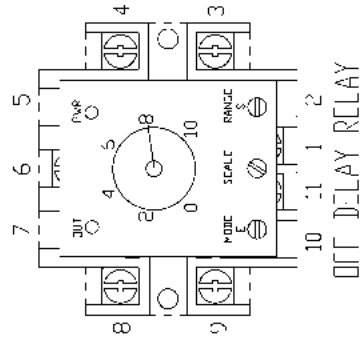

FLAME RJD SWITCHING RELAY

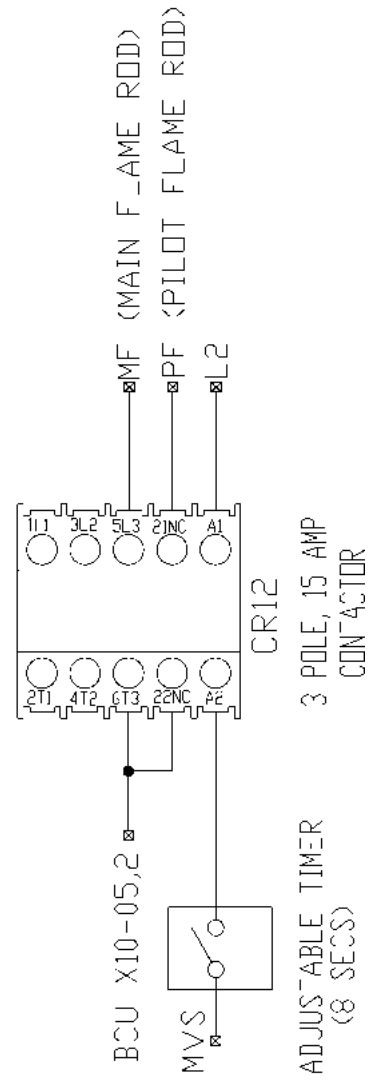

THREE FAN SAFETY RELAY CONFIGURATION

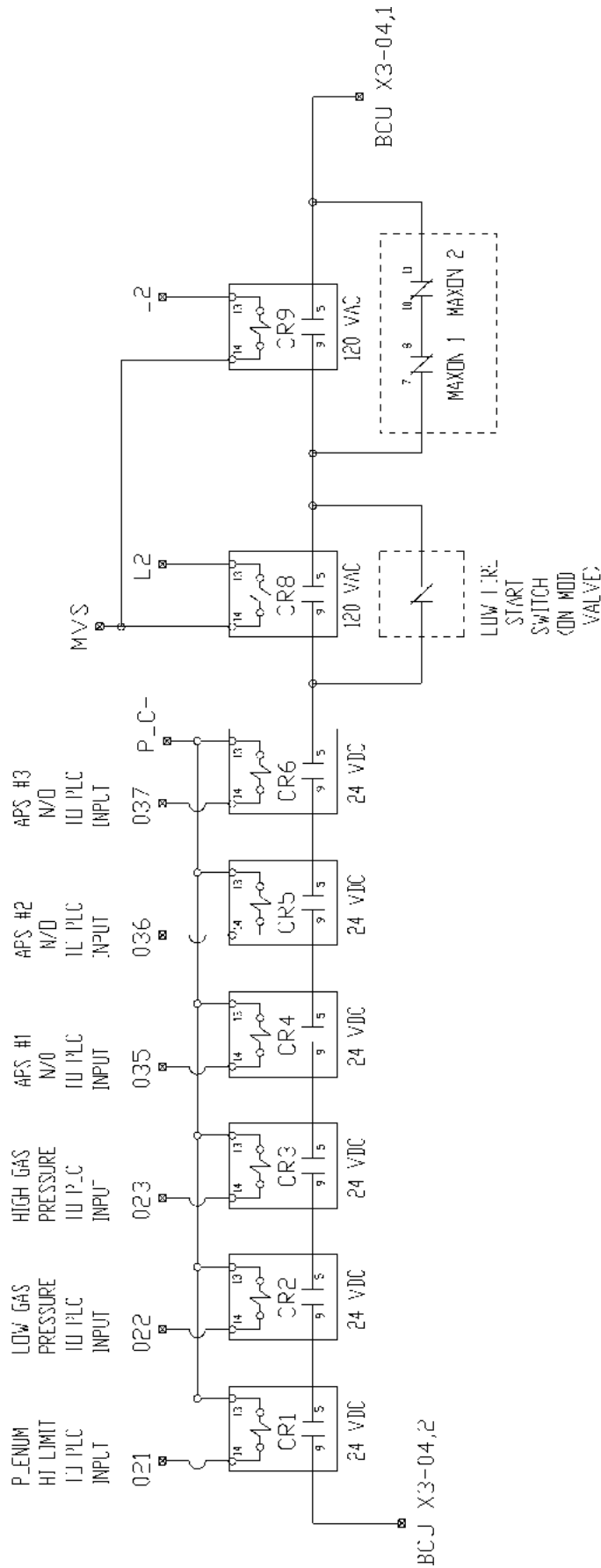

BCU - SIEMENS BURNER CONTROL UNIT
MVS - MAIN GAS VALVE SYSTEM POWER
APS - AIR PROVING (PRESSURE) SWITCH

9. Tower Dryer - CSA Wiring Diagrams

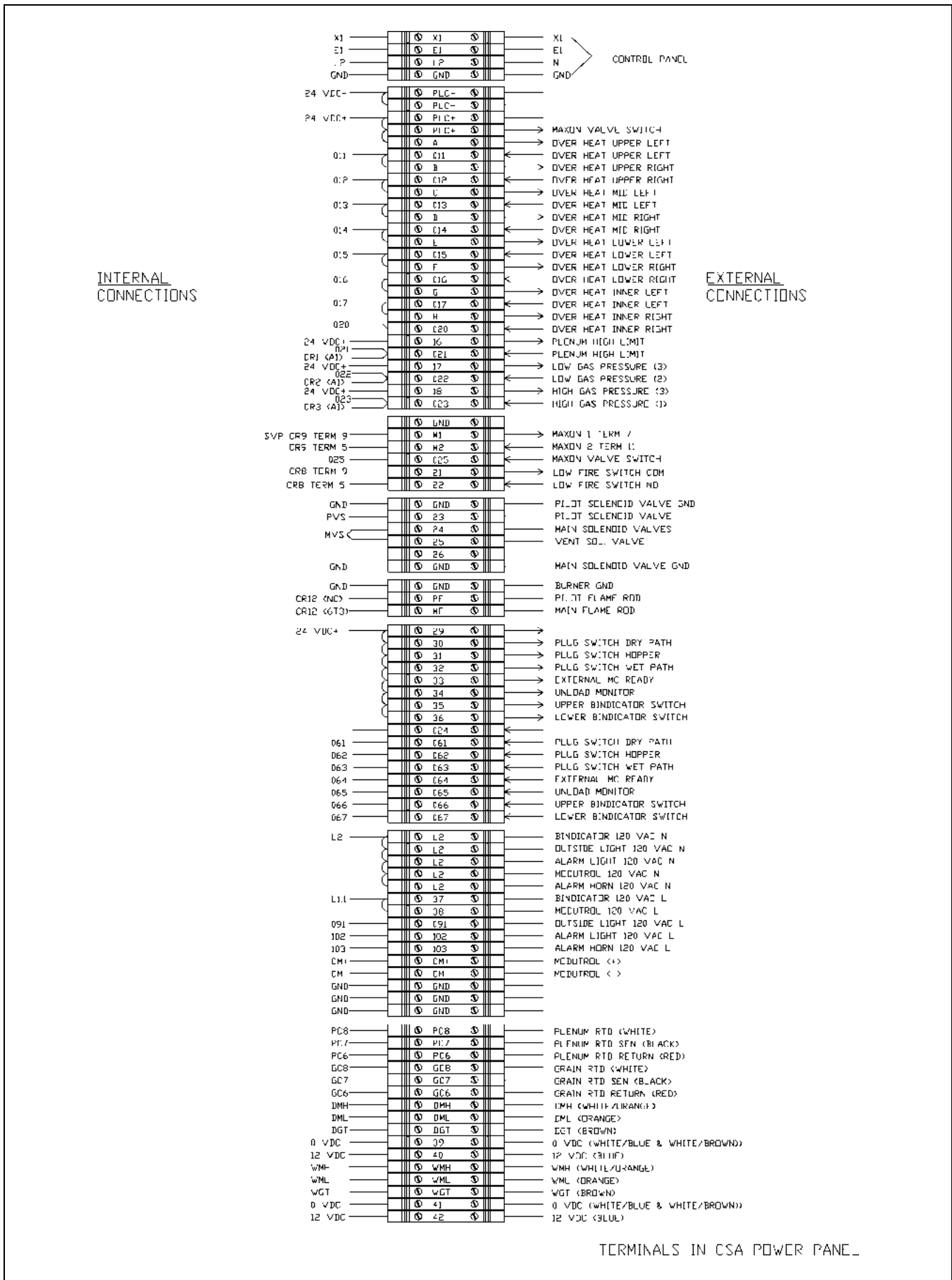

Limited Warranty - N.A. Grain Products

The GSI Group, LLC. ("GSI") warrants products which it manufactures, to be free of defects in materials and workmanship under normal usage and conditions for a period of 12 months from the date of shipment (or, if shipped by vessel, 14 months from the date of arrival at the port of discharge). If, in GSI's sole judgment, a product is found to have a defect in materials and/or workmanship, GSI will, at its own option and expense, repair or replace the product or refund the purchase price. This Limited Warranty is subject to extension and other terms as set forth below.

Warranty Enhancements:

The warranty period for the following products is enhanced as shown below and is in lieu of (and not in addition to) the above stated warranty period. (Warranty Period is from date of shipment.)

	Product	Warranty Period
Storage	Grain Bin Structural Design	5 Years
	• Sidewall, roof, doors, platforms and walkarounds	
	• Flooring (when installed using GSI specified floor support system for that floor)	
Conditioning	Dryer Structural Design - (Tower, Portable and TopDry)	5 Years
	• Includes (frame, portable dryer screens, ladders, access doors and platforms)	
	All other Dryer parts including:	2 Years
	• Electrical (controls, sensors, switches and internal wiring)	
	All Non-PTO Driven Centrifugal and Axial Fans	3 Years
Material Handling	Bullseye Controllers	2 Years
	Bucket Elevators Structural Design	5 Years
	Towers Structural Design	5 Years
	Catwalks Structural Design	5 Years
	Accessories (stairs, ladders and platforms) Structural Design	5 Years

Conditions and Limitations:

THERE ARE NO WARRANTIES THAT EXTEND BEYOND THE LIMITED WARRANTY DESCRIPTION SET FORTH HEREIN; SPECIFICALLY, GSI DISCLAIMS ANY AND ALL OTHER WARRANTIES OF ANY KIND, EXPRESS OR IMPLIED, INCLUDING, WITHOUT LIMITATION, WARRANTIES OF MERCHANTABILITY OR FITNESS FOR A PARTICULAR PURPOSE OR USE IN CONNECTION WITH: (I) ANY PRODUCT MANUFACTURED OR SOLD BY GSI, OR (II) ANY ADVICE, INSTRUCTION, RECOMMENDATION OR SUGGESTION PROVIDED BY AN AGENT, REPRESENTATIVE OR EMPLOYEE OF GSI REGARDING OR RELATED TO THE CONFIGURATION, INSTALLATION, LAYOUT, SUITABILITY FOR A PARTICULAR PURPOSE, OR DESIGN OF SUCH PRODUCTS.

The sole and exclusive remedy for any claimant is set forth in this Limited Warranty and shall not exceed the amount paid for the product purchased. This Warranty only covers the value of the warranted parts and equipment, and does not cover labor charges for removing or installing defective parts, shipping charges with respect to such parts, any applicable sales or other taxes, or any other charges or expenses not specified in this Warranty. GSI shall not be liable for any other direct, indirect, incidental or consequential damages, including, without limitation, loss of anticipated profits or benefits. Expenses incurred by or on behalf of a claimant without prior written authorization from the GSI warranty department shall not be reimbursed. This warranty is not transferable and applies only to the original end-user. GSI shall have no obligation or responsibility for any representations or warranties made by or on behalf of any dealer, agent or distributor. Prior to installation, the end-user bears all responsibility to comply with federal, state and local codes which apply to the location and installation of the products.

This Limited Warranty extends solely to products sold by GSI and does not cover any parts, components or materials used in conjunction with the product, that are not sold by GSI. GSI assumes no responsibility for claims resulting from construction defects, unauthorized modifications, corrosion or other cosmetic issues caused by storage, application or environmental conditions. Modifications to products not specifically delineated in the manual accompanying the product at initial sale will void all warranties. This Limited Warranty shall not extend to products or parts which have been damaged by negligent use, misuse, alteration, accident or which have been improperly/inadequately maintained.

Notice Procedure:

In order to make a valid warranty claim a written notice of the claim must be submitted, using the RMA form, within 60 days of discovery of a warrantable nonconformance. The RMA form is found on the OneGSI portal.

Service Parts:

GSI warrants, subject to all other conditions described in this Warranty, Service Parts which it manufactures for a period of 12 months from the date of purchase unless specified in Enhancements above.

(Limited Warranty - N.A. Grain Products_ revised 01 October 2020)

This equipment shall be installed in accordance with the current installation codes and applicable regulations, which should be carefully followed in all cases. Authorities having jurisdiction should be consulted before installations are made.



1004 E. Illinois St.
Assumption, IL 62510-0020
Phone: 1-217-226-4421
Fax: 1-217-226-4420
www.grainsystems.com

